

ACCESSORIES

Price Guide - 2025 R3



Product Map
Table of Contents

Thank you for choosing BRC

Established in 1979 and incorporated in 1983, BRC Group has grown into a leader in the research, development and manufacturing of high quality ergonomic office furniture. BRC is a Canadian-owned private company with modern manufacturing facilities in Georgetown, Ontario, Canada.

BRC is a forerunner in blending environmental initiatives with the manufacturing of renewable and recyclable products. BRC uses materials and manufacturing processes which virtually eliminate Volatile Organic Chemical (VOC) emissions in the office environment. Raw materials are responsibly sourced, assuring that only the best and most sustainable components are converted to finished goods. BRC is committed to developing and offering the best-value products for the middle and higher end markets.

From OEM solutions to obscure designer requests to simply striving to be better, BRC provides creative and innovative customized solutions to complement any environment and use. Flexible manufacturing offers the ability for BRC to respond to client's special needs rather than having standard catalogue solutions. A wide collection of textiles, laminate finishes and wood veneer allows companies and individuals to express their brand and culture through a unique signature look.

All furniture is designed and manufactured to meet or exceed ANSI-BIFMA standards. Standard construction uses a combination of 3/4" and 1" material with metal to metal commercial grade connections for solid enduring assembly. The newest edge banding technology, in which the edge tape is melted directly to the edge of the board, enables BRC to manufacture products with virtually invisible glue lines.

The BRC Team works hard to earn and keep your business - our success depends on it. If you have any questions or inquiries, please contact us at info@brc.group or toll free at 1-877-260-4309.

We appreciate your business and look forward to hearing from you.

Warranty, Terms & Conditions

BRC is pleased to offer one of the most competitive warranties in the industry. All furniture products carry a 12 year limited structural warranty. BRC furniture panel and table electrical cabling carry a 3 year limited warranty. All moving user adjustable components carry a 5 year limited structural warranty. All other electrical or electronic elements of BRC furniture carry a 1 year limited warranty.

For full warranty details, terms and conditions, please visit www.brc.group/warranty



Guidance & Ordering

PRODUCT IMAGE

PRODUCT DESCRIPTION

FEATURES

Dual Power, Dual USB

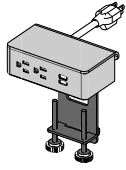

210 CLAMP ON

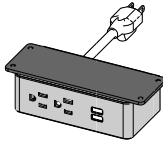

210 UNDERMOUNT

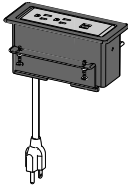

DUO FLUSH MOUNT

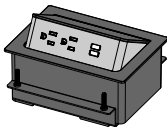

TILT FLUSH MOUNT

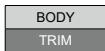

ACCESSORIES PRICE GUIDE 2021 R2

| AC2AE | |
|--|-------|
| FEATURES & SPECIFICATIONS | PRICE |
| <ul style="list-style-type: none"> • Double outlet • Two USB ports • 72" Corded plug • Finish options: Trim: black, silver or white Body: white, grey, black, orange, red, green, blue | 623 |

| AU2AE | |
|--|-------|
| FEATURES & SPECIFICATIONS | PRICE |
| <ul style="list-style-type: none"> • Double outlet • Two USB ports • 72" Corded plug • Finish options: Trim: black, silver or white Body: white, grey, black, orange, red, green, blue | 573 |

| AF2AE | |
|--|-------|
| FEATURES & SPECIFICATIONS | PRICE |
| <ul style="list-style-type: none"> • Double outlet • Two USB ports • 72" Corded plug • Finish options: Trim: black, silver or white Body: white, grey, black, orange, red, green, blue | 583 |

| AT2FE | |
|--|-------|
| FEATURES & SPECIFICATIONS | PRICE |
| <ul style="list-style-type: none"> • Double outlet • Two USB ports • 72" Corded plug • Finish options: Trim: black, silver or white Body: white, grey, black, orange, red, green, blue | 996 |

| ORDER CODE SAMPLE | | |
|-------------------|-------|------|
| ITEM CODE | TRIM | BODY |
| AF2AE | BLACK | GREY |

CATALOG REVISION

ORDER CODE SAMPLE

| |
|--------------------|
| PRODUCT MAP |
| ELECTRICAL |
| WIRE MANAGEMENT |
| UNDER DESK STORAGE |
| TASK LIGHTS |
| DESK SCREENS |
| CONTROLLER |
| GROMMETS |
| KEYBOARD COMBOS |
| KEYBOARD HOLDERS |
| MONITOR ARMS |
| KEYS |
| HOOKS |

LIST PRICE

HYPERLINK TO OTHER ITEMS WITHIN DOCUMENT

Table of Contents

| | | | |
|-----------------------|---|------------------------------------|----|
| Welcome | 2 | Products | |
| Guidance and Ordering | 3 | Single Power, Dual USB | 6 |
| Contents | 4 | Dual Power, Dual USB | 7 |
| Product Map | 5 | Three Power, Dual USB | 8 |
| | | Top Mount Tilting Power Modules | 9 |
| | | Interact G2 Power Module | 10 |
| | | Interact IV G2 Power Module | 11 |
| | | Interface G2 | 12 |
| | | Surface Mount Power & Dual USB | 13 |
| | | Pop-Up Wireless Charger with 2 USB | 14 |
| | | Pop Up- Power Station | 15 |
| | | Villa Undermount | 16 |
| | | Power Bars | 18 |
| | | Power Modules | 19 |
| | | Wire Management | 22 |
| | | Desk Storage | 24 |
| | | Desk Screens | 28 |
| | | Grommets | 30 |
| | | Keyboard Combos | 32 |
| | | Keyboard Platforms | 33 |
| | | Keyboard Mechanisms | 34 |
| | | Keyboard Accessories | 35 |
| | | CPU Holders | 36 |
| | | Monitor Arms | 38 |
| | | Flat Brackets | 42 |
| | | Drawer Box | 43 |
| | | File Hanger Bars | 44 |
| | | Keys & Cores | 45 |
| | | Handles | 47 |
| | | Casters | 48 |
| | | Levellers | 50 |

PRODUCT MAP | ELECTRICAL | WIRE MANAGEMENT | UNDER DESK STORAGE | TASK LIGHTS | DESK SCREENS | CONTROLLER | GROMMETS | KEYBOARD COMBOS | CPU HOLDERS | MONITOR ARMS | KEYS | HOOKS | BRACKETS

Product Map

Electrics and Power Modules

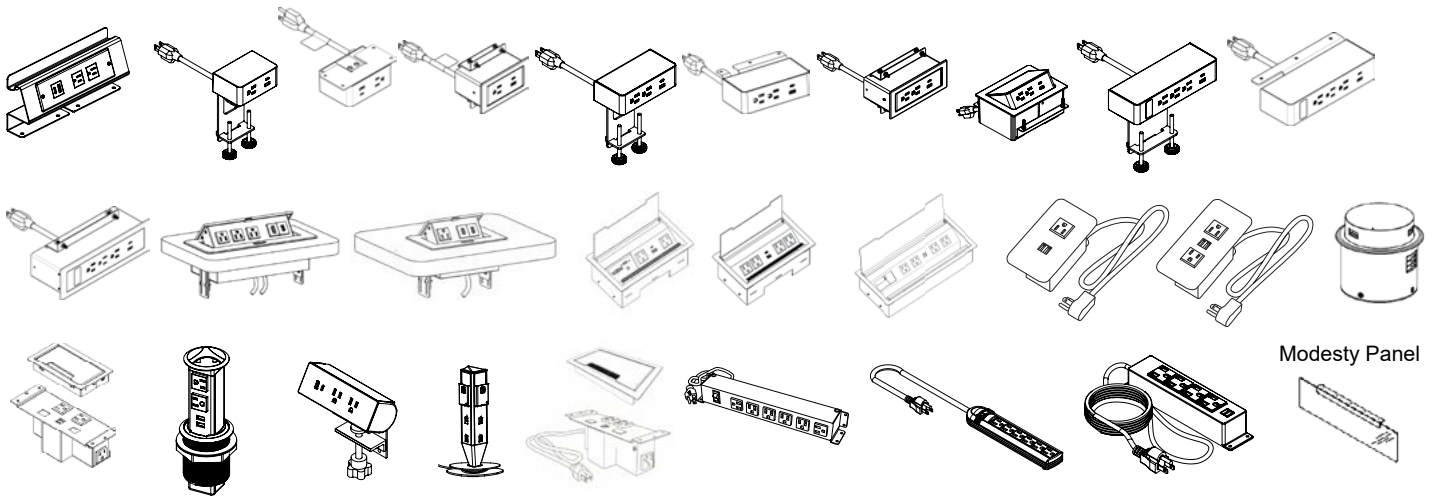

Wire Management

Under Desk Storage

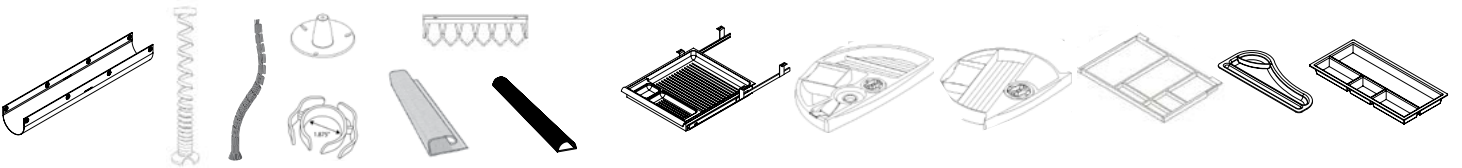

Task Lights

Daisy Chain Power

Ganging Table Bracket

Desk Screens



Controller Options

Grommets

Boot Liner

CPU Holders

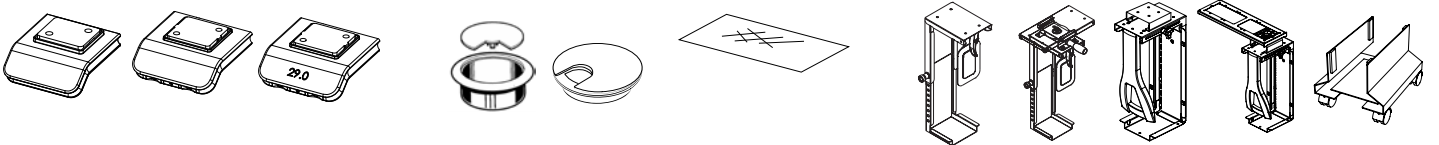

Keyboard Combos

Keyboard Platforms

Keyboard Mechanisms, Corner and Spacers

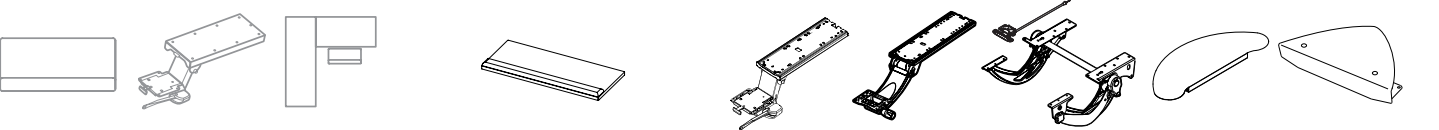

Ventilation Grills

Keys

Mesa T Leg Foot with Caster

Hooks

Monitor Arms & TV Mounts

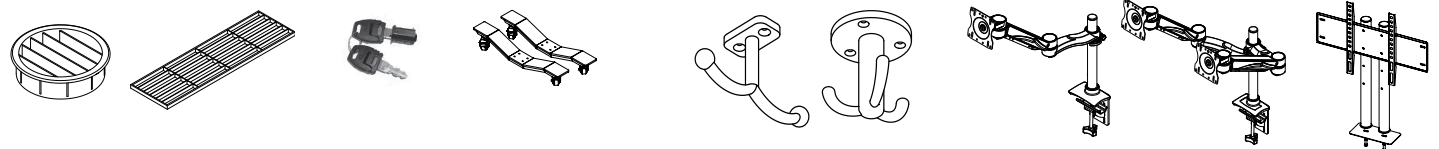

Parts & Pieces

Brackets

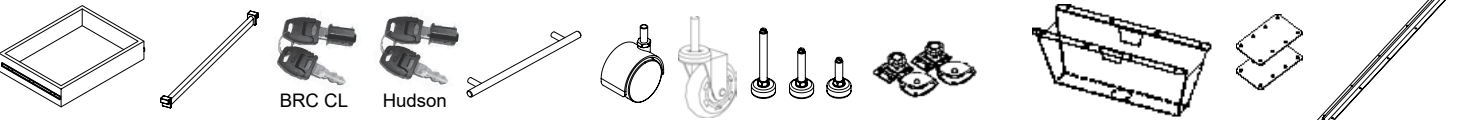

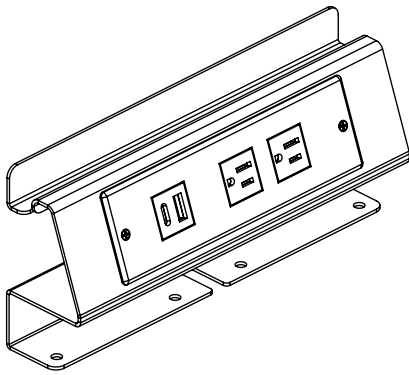

| ACDPE | |
|---|-------|
| FEATURES & SPECIFICATIONS | PRICE |
| <ul style="list-style-type: none"> • Permanently mountable power module, hardware included • Can be mounted from the underside or from the top using screws • Accommodates surfaces up to 1.25" thick • Upper ledge can accommodate mobile phones and tablets • Two 125V AC power outlets • One USB-A power port & one USB-C power port • 10ft power cord • Can not be mounted on a knife edge • Electrical insert finish options: black or white • Mounting bracket available in standard metal paint finishes • Size: 10" w x 2.25"d x 3.375"h | \$467 |



| ORDER CODE SAMPLE |
|-------------------|
| ITEM CODE |
| ACDPE |

Single Power, Dual USB

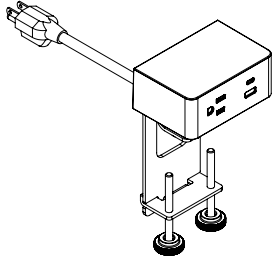

UNO CLAMP ON

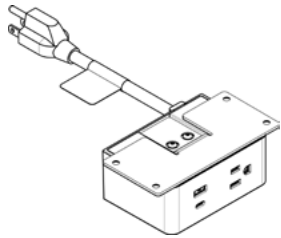

UNO UNDERMOUNT

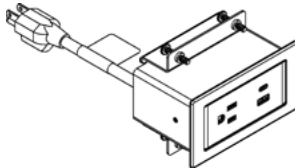

UNO FLUSH MOUNT

| |
|------|
| BODY |
| TRIM |

| AC1AE | |
|--|-------|
| FEATURES & SPECIFICATIONS | PRICE |
| <ul style="list-style-type: none"> • Single outlet • Two USB ports • 72" Black corded plug • Finish options: Trim: black, silver or white Body: white, grey, black, orange, red, green, blue | \$650 |

| AU1AE | |
|--|-------|
| FEATURES & SPECIFICATIONS | PRICE |
| <ul style="list-style-type: none"> • Single outlet • Two USB ports • 72" Black corded plug • Finish options: Trim: black, silver or white Body: white, grey, black, orange, red, green, blue | \$614 |

| AF1AE | |
|--|-------|
| FEATURES & SPECIFICATIONS | PRICE |
| <ul style="list-style-type: none"> • Single outlet • Two USB ports • 72" Black corded plug • Finish options: Trim: black, silver or white Body: white, grey, black, orange, red, green, blue | \$651 |



| ORDER CODE SAMPLE | |
|--------------------------|--------------|
| ITEM CODE | FINISH |
| AU1AE | WHITE/SILVER |

Dual Power, Dual USB

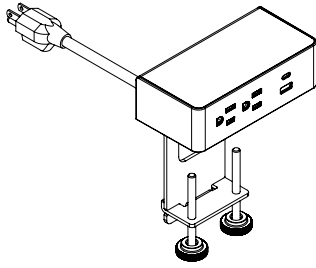

210 CLAMP ON

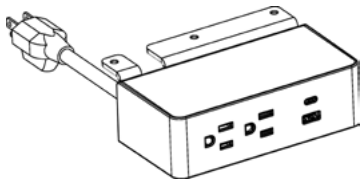

210 UNDERMOUNT

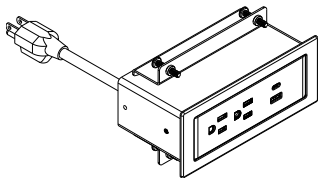

DUO FLUSH MOUNT

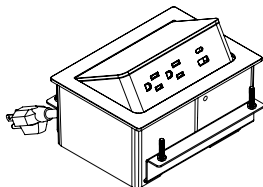

TILT FLUSH MOUNT

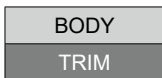

| AC2AE | |
|--|-------|
| FEATURES & SPECIFICATIONS | PRICE |
| <ul style="list-style-type: none"> • Double outlet • Two USB ports • 72" Corded plug • Finish options: Trim: black, silver or white Body: white, grey, black, orange, red, green, blue | \$707 |

| AU2AE | |
|---|-------|
| FEATURES & SPECIFICATIONS | PRICE |
| <ul style="list-style-type: none"> • Double outlet • Two USB ports • 72" Corded plug; optional 10' cord available • Finish options: Trim: black, silver or white Body: white, grey, black, orange, red, green, blue | \$650 |

| AF2AE | |
|--|-------|
| FEATURES & SPECIFICATIONS | PRICE |
| <ul style="list-style-type: none"> • Double outlet • Two USB ports • 72" Corded plug • Finish options: Trim: black, silver or white Body: white, grey, black, orange, red, green, blue | \$661 |

| AT2FE | |
|--|---------|
| FEATURES & SPECIFICATIONS | PRICE |
| <ul style="list-style-type: none"> • Double outlet • Two USB ports • 72" Corded plug • Finish options: Trim: black, silver or white Body: white, grey, black, orange, red, green, blue | \$1,130 |



| ORDER CODE SAMPLE | |
|--------------------------|--------------|
| ITEM CODE | FINISH |
| AF2AE | WHITE/SILVER |

Three Power, Dual USB

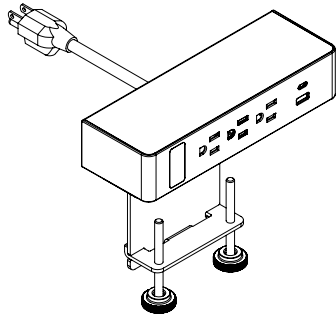

TRIO CLAMP ON

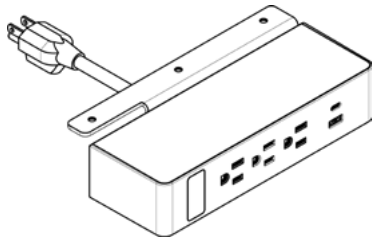

TRIO UNDERMOUNT

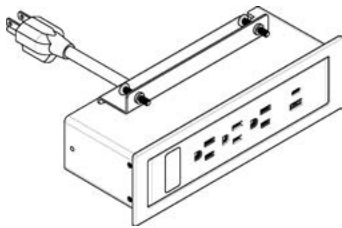

TRIO FLUSH MOUNT

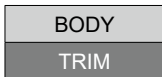

| AC3AE | |
|--|-------|
| FEATURES & SPECIFICATIONS | PRICE |
| <ul style="list-style-type: none"> • Triple outlet • Two USB ports • 72" Corded plug • Finish options: Trim: black, silver or white Body: white, grey, black, orange, red, green, blue | \$805 |

| AU3AE | |
|--|-------|
| FEATURES & SPECIFICATIONS | PRICE |
| <ul style="list-style-type: none"> • Triple outlet • Two USB ports • 72" Corded plug • Finish options: Trim: black, silver or white Body: white, grey, black, orange, red, green, blue | \$723 |

| AF3AE | |
|--|-------|
| FEATURES & SPECIFICATIONS | PRICE |
| <ul style="list-style-type: none"> • Triple outlet • Two USB ports • 72" Corded plug • Finish options: Trim: black, silver or white Body: white, grey, black, orange, red, green, blue | \$780 |



| ORDER CODE SAMPLE | |
|--------------------------|--------------|
| ITEM CODE | FINISH |
| AF3AE | WHITE/SILVER |

Top Mount Tilting

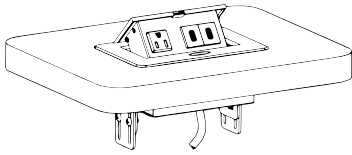

SINGLE OUTLET, 2 USB

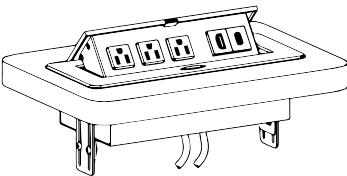

THREE OUTLET, 1 HDMI & 1 USB

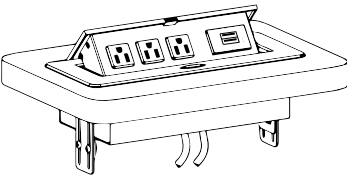

THREE OUTLET, 2 USB

| AT1FE | |
|--|-------|
| FEATURES & SPECIFICATIONS | PRICE |
| <ul style="list-style-type: none"> • Single outlet • 2 USB charging ports with separate power adapter • Push button tilting mechanism • 96" black power cable • Finish options: silver only | \$589 |

| AT3FE | |
|---|-------|
| FEATURES & SPECIFICATIONS | PRICE |
| <ul style="list-style-type: none"> • Triple power outlet • One USB charging port with separate power adapter • One HDMI with connecting cable • Push button tilting mechanism • 96" Black power cable • Finish options: silver only | \$753 |

| AT4FE | |
|--|-------|
| FEATURES & SPECIFICATIONS | PRICE |
| <ul style="list-style-type: none"> • Triple power outlet • Two USB charging ports with separate power adapter • Push button tilting mechanism • 96" Black power cable • Finish options: silver only | \$709 |



| ORDER CODE SAMPLE |
|--------------------------|
| ITEM CODE |
| AT1FE |

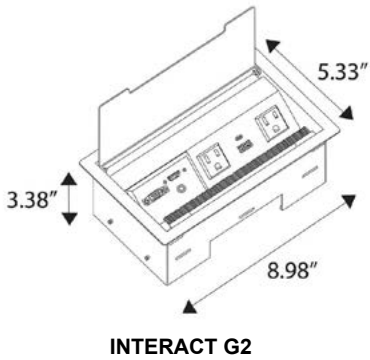

| | |
|--|--|
| AF2RE | FINISH |
| FEATURES & SPECIFICATIONS | PRICE (BLACK, SILVER, WHITE) |
| <ul style="list-style-type: none"> • Two 15A/120V AC Power Receptacles • Additional power outlet on bottom for daisy chaining • One USB-A port and one USB-C port • Hinged lid with brush gasket • 72" Black corded plug • Finish options: black, silver or white • Product ships with blank plate unless additional options below are selected when ordering | \$1,384 |



| OPTION | FEATURE(S) | PRICE |
|--------|---------------------------|--------|
| A | HDMI | +\$391 |
| B | RJ45 CAT6 | +\$243 |
| C | (2) RJ45 CAT6 | +\$483 |
| D | (3) RJ45 CAT6 | +\$723 |
| E | RJ11 CAT3, RJ45 CAT6, USB | +\$811 |
| F | RJ11 CAT3, RJ45 CAT6 | +\$361 |
| G | RJ11 CAT3, (2) RJ45 CAT6 | +\$602 |
| H | (3) RJ45 CAT5E | +\$723 |
| J | VGA, (2) RJ45 CAT6 | +\$772 |





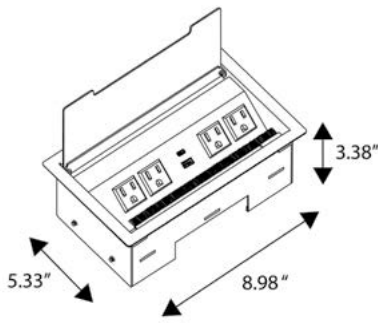





| ORDER CODE SAMPLE | | |
|-------------------|--------|--------|
| ITEM CODE | FINISH | OPTION |
| AF2RE | SILVER | D |



INTERACT IV G2

| | |
|---|--|
| AF4RE | FINISH |
| FEATURES & SPECIFICATIONS | PRICE (BLACK, SILVER, WHITE) |
| <ul style="list-style-type: none"> • Four 15A/120V AC Receptacles • Additional power outlet on bottom for daisy chaining • One USB-A port and one USB-C port • Hinged lid with brush gasket • 72" black corded plug • Finish options: black, silver or white • Product ships with blank plate unless additional options below are selected when ordering | \$1,963 |



| OPTION | FEATURE(S) | PRICE |
|--------|--|--------|
| A |  HDMI | +\$391 |
| B |  RJ45 CAT6 | +\$243 |
| C |  (2) RJ45 CAT6 | +\$483 |
| D |  (3) RJ45 CAT6 | +\$723 |
| E |  RJ11 CAT3, RJ45 CAT6, USB | +\$811 |
| F |  RJ11 CAT3, RJ45 CAT6 | +\$361 |
| G |  RJ11 CAT3, (2) RJ45 CAT6 | +\$602 |
| H |  (3) RJ45 CAT5E | +\$723 |
| J |  VGA, (2) RJ45 CAT6 | +\$772 |





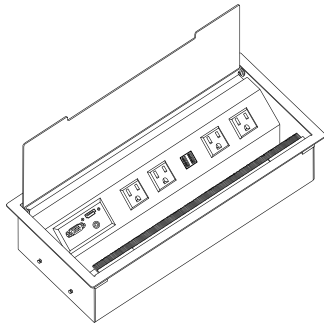







| ORDER CODE SAMPLE | | |
|-------------------|--------|--------|
| ITEM CODE | FINISH | OPTION |
| AF4RE | SILVER | B |



INTERFACE G2

| AF4AE | | |
|--|------------------------------|--|
| FEATURES & SPECIFICATIONS | PRICE (BLACK, SILVER, WHITE) | PRICE (ANODIZED ALUMINUM, STAINLESS STEEL) |
| <ul style="list-style-type: none"> • Four outlets on top • Additional power outlet on bottom for daisy chaining • Two USB ports • Hinged lid with brush gasket • 72" Black corded plug • Finish options: black, silver or white • Brushed anodized aluminum, brushed stainless steel <p>• Product ships with blank plate unless additional options below are selected when ordering</p> | \$2,855 | \$4,062 |



| OPTION | FEATURE(S) | PRICE |
|--------|---|--------|
| A |  HDMI | +\$391 |
| B |  RJ45 CAT6 | +\$243 |
| C |  (2) RJ45 CAT6 | +\$483 |
| D |  (3) RJ45 CAT6 | +\$723 |
| E |  RJ11 CAT3, RJ45 CAT6, USB | +\$811 |
| F |  RJ11 CAT3, RJ45 CAT6 | +\$361 |
| G |  RJ11 CAT3, (2) RJ45 CAT6 | +\$602 |
| H |  (3) RJ45 CAT5E | +\$723 |
| J |  VGA, (2) RJ45 CAT6 | +\$772 |
| K |  VGA, RJ45 CAT6, STEREO 3.5 | +\$650 |



| ORDER CODE SAMPLE | | |
|-------------------|--------|--------|
| ITEM CODE | FINISH | OPTION |
| AF4AE | SILVER | C |

Surface Mount Power & Dual USB

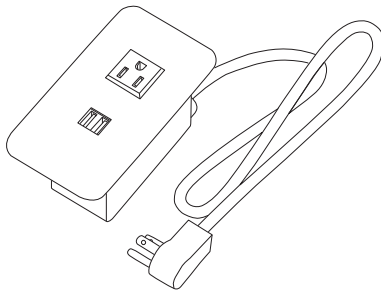

**COVE SURFACE MOUNT
SINGLE**

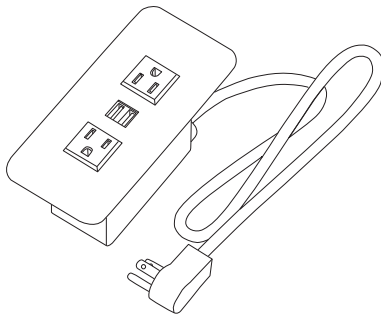

**COVE SURFACE MOUNT
DUAL**

| AF1BE | FINISH | |
|--|---|--|
| FEATURES & SPECIFICATIONS | PRICE (BLACK, SILVER, WHITE) | PRICE (ANODIZED ALUMINUM) |
| <ul style="list-style-type: none"> • Single outlet • Dual USB charging outlets • 108" Black corded plug • Finish options: black, silver, white or clear brushed aluminum | \$984 | \$1,120 |

| AF2BE | FINISH | |
|--|---|--|
| FEATURES & SPECIFICATIONS | PRICE (BLACK, SILVER, WHITE) | PRICE (ANODIZED ALUMINUM) |
| <ul style="list-style-type: none"> • Dual outlet • Dual USB charging outlets • 108" Black corded plug • Finish options: black, silver, white or clear brushed aluminum | \$1,287 | \$1,430 |



| ORDER CODE SAMPLE | |
|--------------------------|---------------|
| ITEM CODE | FINISH |
| AF1BE | SILVER |

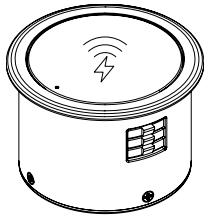

CLOSED - FLUSH

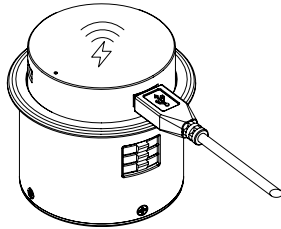

OPEN - USB ACCESS

WIRELESS CHARGING

AF0WE

FEATURES & SPECIFICATIONS

- Flush mount
- Pop up design allows simultaneous wireless and access to three USB charging ports
- Three inch hole required for mounting
- Qi compatible
- Will charge through surface up to 1/8"
- Finish options: black only

PRICE

\$431



ORDER CODE SAMPLE

ITEM CODE

AF0WE

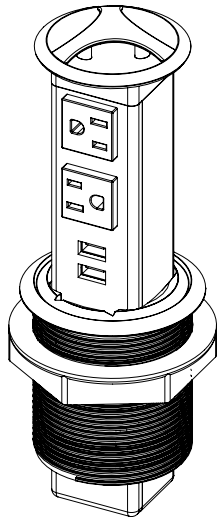

**RETRACTABLE POWER
STATION**

| AP2FE | |
|--|-------|
| FEATURES & SPECIFICATIONS | PRICE |
| <ul style="list-style-type: none"> • Three inch hole required for mounting • Two AC receptacles, 120v/ 60hz • Two USB 2.1A charging ports • Requires 12" (305mm) space under work surface • Pull up design • 6Ft grounded power cord • Finish options: black only | \$453 |



| ORDER CODE SAMPLE |
|-------------------|
| ITEM CODE |
| AP2FE |

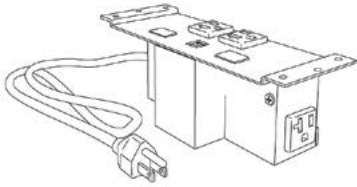

POWER BASE

| AU2FE | |
|---|-------|
| FEATURES & SPECIFICATIONS | PRICE |
| <ul style="list-style-type: none"> • Two power outlets • Two USB charging ports • 72" Black corded plug • Base finish options: black, white or silver • Optional data, video and stereo options as per below • Select cover grommet to complete product | \$923 |



| OPTION | FEATURE(S) | PRICE |
|--------|--|--------|
| C |  (2) RJ45 CAT6 | +\$483 |

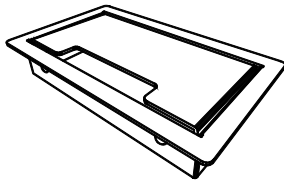

COVER GROMMET

| COVER | | |
|-------|-------------------|--------|
| MODEL | FINISH | PRICE |
| F-AL | BRUSHED ALUMINUM | +\$526 |
| F-S | SILVER PAINT | +\$264 |
| F-B | BLACK PAINT | +\$264 |
| F-W | GLOSS WHITE PAINT | +\$264 |



| ORDER CODE SAMPLE | | |
|------------------------|-------------------|--------|
| ITEM CODE - POWER BASE | ITEM CODE - COVER | OPTION |
| AU2FE | F-SS | K |

Villa Undermount for Training Table Applications

ADV1E: Villa Single Undermount

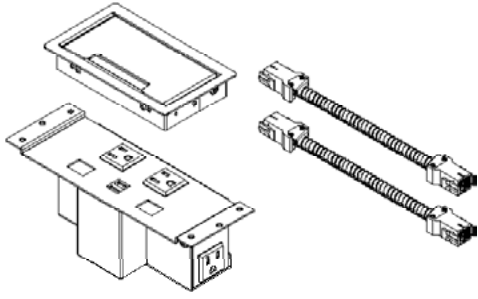

ADV2E: Villa Double Undermount

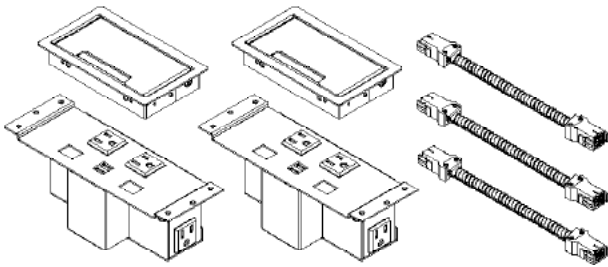

| ADV1E | |
|---|-------|
| FEATURES & SPECIFICATIONS | PRICE |
| <ul style="list-style-type: none"> Includes single power unit, cover, FF cable & FM cable Two power outlets per unit Two USB charging ports per unit Base finish options: black or silver Select cover finish below and add upcharge For infeed cable, add product ADPIE | \$882 |

| ADV2E | |
|---|---------|
| FEATURES & SPECIFICATIONS | PRICE |
| <ul style="list-style-type: none"> Includes two power units, two covers, two FF cables & one FM cable Two power outlets per unit Two USB charging ports per unit Base finish options: black or silver Select cover finish below and add upcharge For infeed cable, add product ADPIE | \$1,550 |

| BASE FINISH | | |
|-------------|--------------|----------|
| MODEL | FINISH | PRICE |
| BLK | BLACK PAINT | INCLUDED |
| SLV | SILVER PAINT | INCLUDED |

| COVER FINISH | | |
|--------------|-------------------|--------|
| MODEL | FINISH | PRICE |
| F-AL | BRUSHED ALUMINUM | +\$526 |
| F-S | SILVER PAINT | +\$264 |
| F-B | BLACK PAINT | +\$264 |
| F-W | GLOSS WHITE PAINT | +\$264 |

| OPTION | FEATURE(S) | PRICE |
|--------|---|--------|
| C |  (2) RJ45 CAT6 | +\$483 |

Power Bars

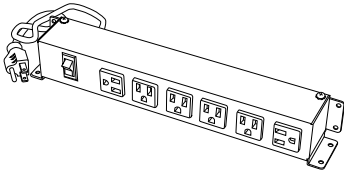

POWER HUB

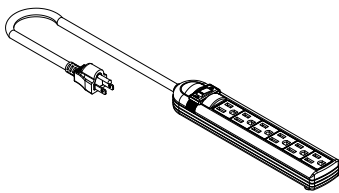

POWER BAR

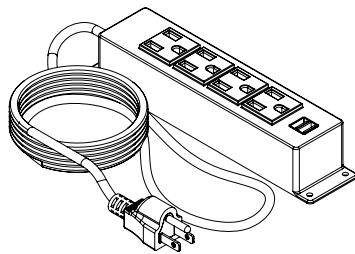

AL6HE

| FEATURES & SPECIFICATIONS | PRICE |
|---|-------|
| <ul style="list-style-type: none"> • 6 Outlet with on/off circuit breaker switch • Heavy duty commercial all metal construction and performance • 108" Corded plug • Under worksurface and/or modesty panel mount provides power to electric table and multiple devices • Finish: black powdercoat | \$526 |

AL6PE

| FEATURES & SPECIFICATIONS | PRICE |
|---|-------|
| <ul style="list-style-type: none"> • 6 Outlet power bar with on/off switch and surge protection • 10' Power cord • 15 Amp • Black plastic housing | \$245 |

AL4BE

| FEATURES & SPECIFICATIONS | PRICE |
|---|-------|
| <ul style="list-style-type: none"> • 4 Outlet power bar with 2 USB charging ports • Easy surface mounting tabs • 15' Power cord • 15 Amp • Black plastic housing | \$123 |



| ORDER CODE SAMPLE |
|-------------------|
| ITEM CODE |
| AL6HE |

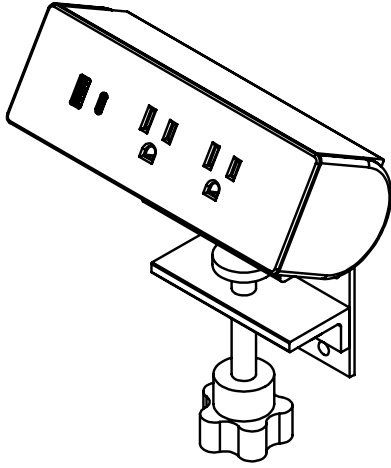

| AC2AC | |
|--|-------|
| FEATURES & SPECIFICATIONS | PRICE |
| <ul style="list-style-type: none"> • Desk mount clamp • Two 15A, 125V AC power outlet • One USB-A power port & one USB-C power port • 9ft Grounded power cord • Finish options: black or white • Size: 6.18" w x 4.43"d x 3.5" h | \$212 |



| ORDER CODE SAMPLE |
|-------------------|
| ITEM CODE |
| AC2AC |

Freestanding Power Module

AFRSE

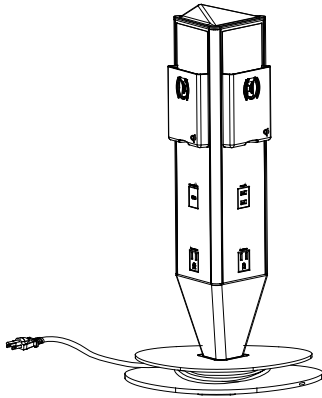

AFRSE

FEATURES & SPECIFICATIONS

- Freestanding power module
- Three AC receptacles, 120v/ 60hz 12A
- Three Qi wireless rapid chargers
- Two USB-A and one USB-C charging ports,
- 10ft Grounded power cord
- Finish options: silver only
- 11.28"w x 11.16"d x 19.82"h

PRICE

\$3,284



ORDER CODE SAMPLE

ITEM CODE

AFRSE

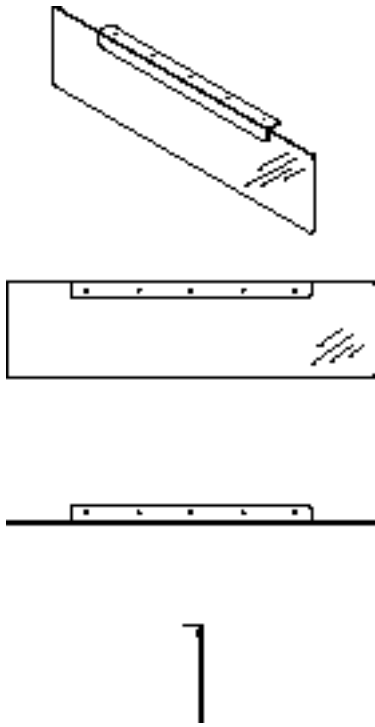

| OVERALL SIZE | | | |
|--------------|--------|--------------------------|---------|
| WIDTH | HEIGHT | FOR USE WITH TABLE WIDTH | PRICE |
| 28 | 12 | 36 | \$460 |
| 34 | 12 | 42 | \$536 |
| 40 | 12 | 48 | \$617 |
| 46 | 12 | 54 | \$693 |
| 52 | 12 | 60 | \$774 |
| 58 | 12 | 66 | \$851 |
| 64 | 12 | 72 | \$931 |
| 70 | 12 | 78 | \$1,007 |
| 76 | 12 | 84 | \$1,084 |

Features & Specifications

No Charge Options



| ORDER CODE SAMPLE | |
|-------------------|-------|
| ITEM CODE | WIDTH |
| AAMPA | 46 |

- Includes 3/4" fasteners
 - Modesty panel constructed from 1/4" frosted (one side) acrylic panel
 - Panel sized to be 8" less than the mounting surface width (eg. 60" width uses 52" modesty)
-
- All standard metal finishes available

Under Worksurface

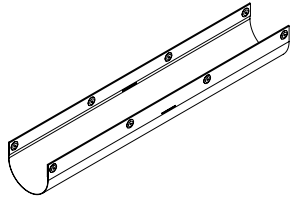

CABLE HAMMOCK WIRE MANAGER

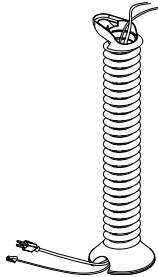

CABLE MANAGEMENT COIL



CABLE MANAGEMENT SPINE

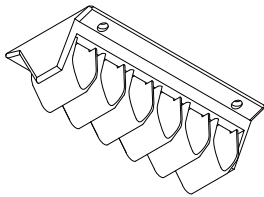

CABLE CLAMP

| AVCSE | |
|---|-------|
| FEATURES & SPECIFICATIONS | PRICE |
| <ul style="list-style-type: none"> • Width is 36", depth is 10" • Height under worksurface is 5" after installation • Designed to fit the Mesa height adjustable table frame • Attaches to frame using magnets • Can also be attached to underside of worksurface using screws • Made from flexible woven seam welded mesh • Includes 2" opening midway on both sides for cable access • Max weight capacity of 5 lbs • Finish options: dark grey only | \$160 |

| AW12A | |
|--|-------|
| FEATURES & SPECIFICATIONS | PRICE |
| <ul style="list-style-type: none"> • Spiral coil design 3 3/8" diameter • Mounting top bracket; weighted 6" diameter base • Stretches to 84" • Finish options: black, silver & white | \$165 |

| AW13A | |
|---|-------|
| FEATURES & SPECIFICATIONS | PRICE |
| <ul style="list-style-type: none"> • Black or silver plastic finish • 15 Ring column; 35.5" overall height; 2.25" diameter • Mounting top bracket; weighted base | \$254 |

| ORDER CODE | SIZE | | |
|---|--------|-------|-------|
| MODEL | LENGTH | RINGS | PRICE |
| AW14A | 3.58 | 4 | \$51 |
| AW15A | 5.35 | 6 | \$67 |
| FEATURES & SPECIFICATIONS | | | |
| <ul style="list-style-type: none"> • Width is 2.5", height is 1.25" • Under work surface mounting • Electrical and data wires slide into removable rings • Finish options: black only | | | |



| ORDER CODE SAMPLE | |
|-------------------|--------------|
| ITEM CODE | OPTION |
| AW13A | <i>BLACK</i> |

PRODUCT MAP
ELECTRICAL
WIRE MANAGEMENT
UNDER DESK STORAGE
TASK LIGHTS
DESK SCREENS
CONTROLLER
GROMMETS
KEYBOARD COMBOS
CPU HOLDERS
MONITOR ARMS
KEYS
HOOKS
BRACKETS

Wire Managers

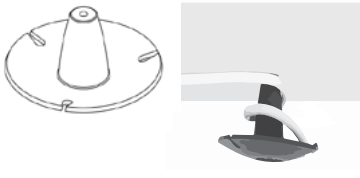

WRAP AROUND WIRE CLIP

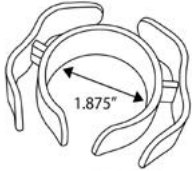

CABLE CLIP



LARGE WIRE MANAGER



SMALL WIRE MANAGER

| AW16A | |
|---|-------|
| FEATURES & SPECIFICATIONS | PRICE |
| <ul style="list-style-type: none"> • After mounting undersurface, wire wraps around and clips • 4" Diameter by 2" tall • Colour options: grey only | \$93 |

| AW17A | |
|---|-------|
| FEATURES & SPECIFICATIONS | PRICE |
| <ul style="list-style-type: none"> • 1.875" Diameter; accommodates 2" diameter post leg • Snaps on • Finish option: aluminum silver only | \$50 |

| AWMCA | |
|--|-------|
| LENGTH | PRICE |
| 6 | \$25 |
| 12 | \$49 |
| 18 | \$74 |
| 24 | \$96 |
| 36 | \$112 |
| FEATURES & SPECIFICATIONS | |
| <ul style="list-style-type: none"> • Black plastic finish • Includes adhesive mounting tape • Approx size 1.5" Wide x 0.875" High | |

| AVWMA | |
|---|--------------|
| FEATURES & SPECIFICATIONS | PRICE PER FT |
| <ul style="list-style-type: none"> • Specify length required to a maximum of 6ft (72") • Black plastic finish • Includes adhesive mounting tape • Approx size 0.75" Wide x 0.75" High | \$30 |



| ORDER CODE SAMPLE |
|--------------------------|
| ITEM CODE |
| AW17A |

Under Desk Storage

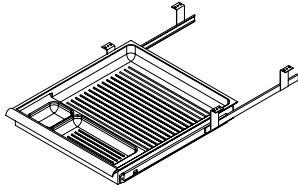

3 COMPARTMENT PENCIL DRAWER

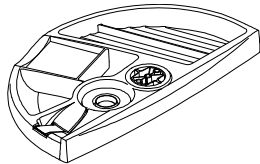

LARGE CIRCULAR DRAWER

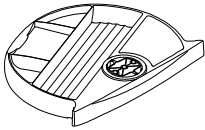

SMALL CIRCULAR DRAWER

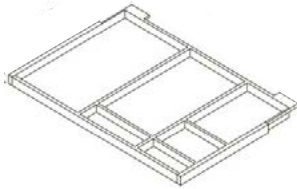

6 COMPARTMENT PENCIL DRAWER

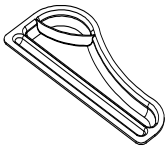

PENCIL TRAY

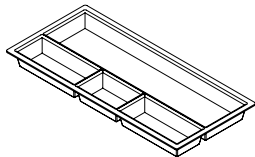

RECTANGULAR PENCIL TRAY

| AP12A | |
|--|-------|
| FEATURES & SPECIFICATIONS | PRICE |
| <ul style="list-style-type: none"> • Slide out design • Integral plastic slides mount easily under worksurface • Textured plastic • Finish options: black • Width: 15 1/4" • Installed depth: 15 1/4" • Extended depth: 26" | \$166 |

| AP13A | |
|---|-------|
| FEATURES & SPECIFICATIONS | PRICE |
| <ul style="list-style-type: none"> • Circular swivel design • Under work surface application • 13 19/32" Long, 1 1/4" high, 7 13/32" deep • Plastic • Finish options: matte black, metallic silver | \$231 |

| AP14A | |
|--|-------|
| FEATURES & SPECIFICATIONS | PRICE |
| <ul style="list-style-type: none"> • Circular swivel design • Under work surface application • 9" Long, 1" high, 7 13/32" deep • Plastic • Finish options: matte black, metallic silver | \$240 |

| AP15A | |
|---|-------|
| FEATURES & SPECIFICATIONS | PRICE |
| <ul style="list-style-type: none"> • Slide out design • Integral plastic slides mount easily under worksurface • Textured plastic • Finish options: black • Width: 22 3/8" • Depth: 15 3/8" | \$249 |

| AP16A | |
|--|-------|
| FEATURES & SPECIFICATIONS | PRICE |
| <ul style="list-style-type: none"> • Fits in pedestal width drawer; includes attachment tab & hardware • Textured plastic • Finish options: black • Size: 12" x 6" | \$39 |

| AP17A | |
|--|-------|
| FEATURES & SPECIFICATIONS | PRICE |
| <ul style="list-style-type: none"> • Sits in pedestal width drawer • Textured plastic • Finish options: black • Size: 12" x 6" | \$72 |

▽

| ORDER CODE SAMPLE | |
|--------------------------|--------------|
| ITEM CODE | FINISH |
| AP14A | <i>BLACK</i> |

BRACKETS | HOOKS | KEYS | MONITOR ARMS | CPU HOLDERS | KEYBOARD COMBOS | GROMMETS | CONTROLLER | DESK SCREENS | TASK LIGHTS | UNDER DESK STORAGE | WIRE MANAGEMENT | ELECTRICAL | PRODUCT MAP



| ORDER CODE | | | |
|------------|--------|-------|-------|
| MODEL | LENGTH | WATTS | PRICE |
| ALTFE | 24 | 14 | \$213 |
| ALTFE | 36 | 21 | \$290 |
| ALTFE | 48 | 28 | \$382 |

| FEATURES & SPECIFICATIONS |
|---|
| <ul style="list-style-type: none"> • Energy efficient replaceable T5 fluorescent light • Light head swivels 160° • On all lengths height is 1.1" and width is 3.29" • 4,100K temperature • Includes screws for wood mounting and magnets for metal mounting • 108" Black power cord included • Finish: silver only |



| ORDER CODE SAMPLE | |
|-------------------|------|
| ITEM CODE | SIZE |
| ALTFE | 36" |



Good To Know

- Lengths are actual size so when choosing to fit in a space, go a size down. For instance, on a 48" wide hutch, order the 36" size task light as the space inside the hutch is less than 48".

Freestanding LED Task Light

AFTLE

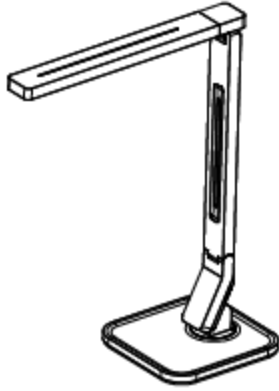

| AFTLE | |
|---|-------|
| FEATURES & SPECIFICATIONS | PRICE |
| <ul style="list-style-type: none"> • Freestanding LED desktop task light • Includes USB charging • 960 Lumens with dimming • 6.75"w x 15.16"d x 18"h • Includes plug in power adapter • Finish: white | \$408 |



| ORDER CODE SAMPLE |
|-------------------|
| ITEM CODE |
| AFTLE |

Desk Screens

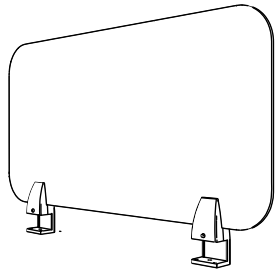

EDGE OF DESK MOUNT

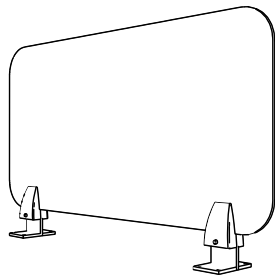

BETWEEN DESK MOUNT

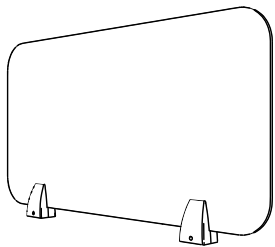
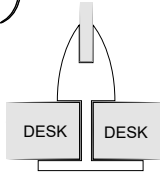

FLUSH MOUNT

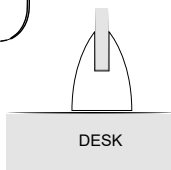

| ORDER CODE | SIZE | |
|------------|--------|-------|
| MODEL | LENGTH | PRICE |
| ADS1A | 20 | \$315 |
| ADS1A | 24 | \$382 |
| ADS1A | 30 | \$443 |
| ADS1A | 36 | \$507 |
| ADS1A | 48 | \$635 |
| ADS1A | 60 | \$762 |

| FEATURES & SPECIFICATIONS | | |
|--|--|--|
| <ul style="list-style-type: none"> • 15" Overall height • Mounts to edge of 1" thick desk • 0.25" Frosted both sides acrylic • Hardware finish options: black, white, silver | ADS1A – Width is nominal. Actual width is nominal less 1.55" – Height is actual but there is a 0.5" gap between the bottom of the screen and the worksurface. For other reference notes this is the same as the product in our health care guide HDS1A (p.35). | |

| ORDER CODE | SIZE | |
|------------|--------|-------|
| MODEL | LENGTH | PRICE |
| ADS2A | 20 | \$315 |
| ADS2A | 24 | \$382 |
| ADS2A | 30 | \$443 |
| ADS2A | 36 | \$507 |
| ADS2A | 48 | \$634 |
| ADS2A | 60 | \$762 |

| FEATURES & SPECIFICATIONS | | |
|--|--|--|
| <ul style="list-style-type: none"> • 15" Overall height • Mounts in between 1" thick surfaces • 0.25" Frosted both sides acrylic • Hardware finish options: black, white, silver | ADS2A – Width is nominal. Actual width is nominal less 1.55" – Height is actual but there is a 0.5" gap between the bottom of the screen and the worksurface. For other reference notes this is the same as the product in our health care guide HDS2A (p.36). | |

| ORDER CODE | SIZE | |
|------------|--------|-------|
| MODEL | LENGTH | PRICE |
| ADS3A | 20 | \$297 |
| ADS3A | 24 | \$360 |
| ADS3A | 30 | \$425 |
| ADS3A | 36 | \$488 |
| ADS3A | 48 | \$617 |
| ADS3A | 60 | \$745 |

| FEATURES & SPECIFICATIONS | | |
|---|--|--|
| <ul style="list-style-type: none"> • 15" Overall height • Flush mount to top of desk • 0.25" Frosted both sides acrylic • Hardware finish options: black, white, silver | ADS3A – Width is nominal. Actual width is nominal less 1.55" – Height is actual but there is a 0.5" gap between the bottom of the screen and the worksurface. For other reference notes this is the same as the product in our health care guide HDS3A (p.37). | |



| ORDER CODE SAMPLE | | |
|-------------------|------|--------|
| ITEM CODE | SIZE | FINISH |
| ADS3A | 30" | BLACK |

Height Adjustable Table Accessories

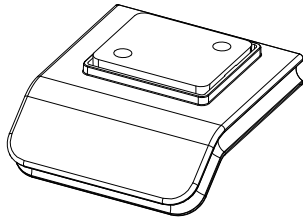

BASIC CONTROLLER

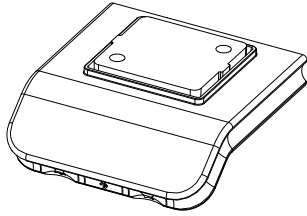

CONTROLLER WITH BLUETOOTH

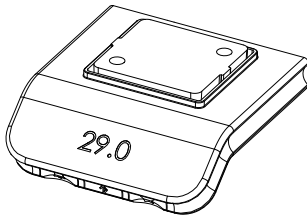

CONTROLLER WITH BLUETOOTH AND HEIGHT DISPLAY

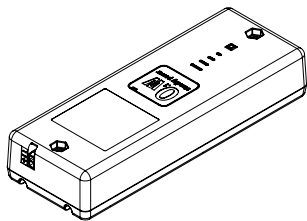

RECHARGEABLE BATTERY FOR VIVA, SOHO & NOLITA

Product Notes

- These controllers & battery are not available for alta electric tables.
- Contact brc for a link to download the desk control app for iOS and android.



| ORDER CODE SAMPLE |
|-------------------|
| ITEM CODE |
| AE1CE |

| AE1KE | |
|--|-------|
| FEATURES & SPECIFICATIONS | PRICE |
| <ul style="list-style-type: none"> • Standard on all Viva electric height adjustable tables • Lift up to raise, push down to lower | \$129 |

| AE1BE | |
|--|-------|
| FEATURES & SPECIFICATIONS | PRICE |
| <ul style="list-style-type: none"> • Lift up to raise, push down to lower • 2 Memory positions • LED light strip reminder • Bluetooth via desk control app • Optional on all Viva electric height adjustable tables • Replaces standard controller DPG1K | \$314 |

| AE1CE | |
|--|-------|
| FEATURES & SPECIFICATIONS | PRICE |
| <ul style="list-style-type: none"> • Lift up to raise, push down to lower • 4 Memory positions • LED light strip reminder • Digital height display in metric or imperial units • Bluetooth via desk control app • Standard on all Soho and NoLita electric height adjustable tables, optional on all Viva tables • Replaces standard controller DPG1K | \$395 |

| AEBAE | |
|--|---------|
| FEATURES & SPECIFICATIONS | PRICE |
| <ul style="list-style-type: none"> • For use with Viva, Soho and NoLita product only; not for use with Alta • High performance 2.2 Ah lithium-ion battery • Typically achieves 50-100 full stroke up and down cycles • Features LED light bar indicating capacity • Audible alarm when charging is required • Can be charged with existing table power cord or included external charging cable • Colour: black only • Includes mounting bracket, connecting cable & external charging cable | \$1,590 |

Grommets



3" GROMMET



2.5" GROMMET



1.75" GROMMET

| AG30A | | |
|--|--------------------|-----------------|
| FEATURES & SPECIFICATIONS | PRICE GROMMET ONLY | PRICE INSTALLED |
| <ul style="list-style-type: none"> • Round grommet with removable cover • Fits 80mm hole • Finish: black or white | \$38 | \$86 |

| AG25A | | |
|--|--------------------|-----------------|
| FEATURES & SPECIFICATIONS | PRICE GROMMET ONLY | PRICE INSTALLED |
| <ul style="list-style-type: none"> • Round grommet with removable cover • Fits 60mm hole • Finish: black only | \$37 | \$85 |

| AG17A | | |
|--|--------------------|-----------------|
| FEATURES & SPECIFICATIONS | PRICE GROMMET ONLY | PRICE INSTALLED |
| <ul style="list-style-type: none"> • Round grommet with removable cover • Fits 45mm hole • Finish: black only | \$36 | \$84 |



| ORDER CODE SAMPLE | |
|--------------------------|--------|
| ITEM CODE | OPTION |
| AG25A | BLACK |

Ventilation Grills

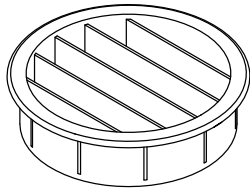

ROUND

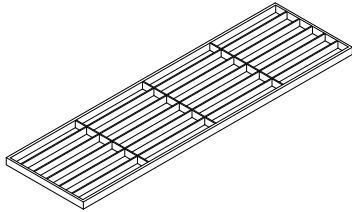

RECTANGLE

| ORDER CODE | | SIZE | | |
|---|--|----------|--------|-------|
| MODEL | | DIAMETER | HEIGHT | PRICE |
| AGVCA | | 76 mm | 20 mm | \$70 |
| FEATURES & SPECIFICATIONS | | | | |
| <ul style="list-style-type: none"> • Black or white colour option • Material is plastic | | | | |

| ORDER CODE | | SIZE | | | |
|---|--|-------|--------|--------|-------|
| MODEL | | WIDTH | LENGTH | HEIGHT | PRICE |
| AGVRA | | 85 mm | 300 mm | 7 mm | \$85 |
| FEATURES & SPECIFICATIONS | | | | | |
| <ul style="list-style-type: none"> • Black only • Material is plastic | | | | | |



| ORDER CODE SAMPLE | |
|-------------------|--------------|
| ITEM CODE | FINISH |
| AGVRA | <i>BLACK</i> |

Keyboard Combos

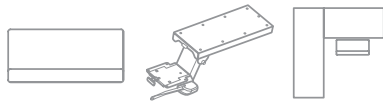

KBTW27 / KBWS-L17

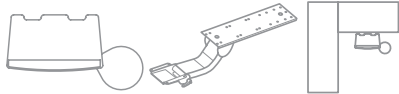

KBT(MS)RM / KBSS

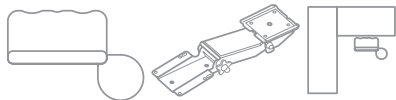

KBT(90)BRM / KBKS-21

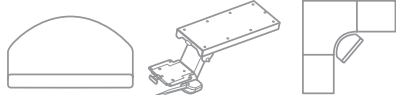

KBC-12 / KBWS-L22

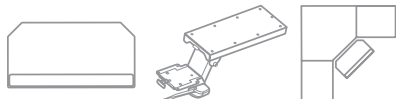

KBT-DC17 / KBWS-L22

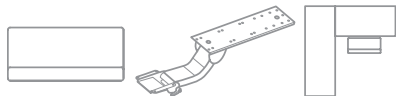

KBTW27 / KBSS

| AK04A | |
|--|---------|
| FEATURES & SPECIFICATIONS | PRICE |
| <ul style="list-style-type: none"> • Standard 27" wide rectangular tray. • Keyboard and mouse tray with vinyl wrist rest • Finish: black only | \$1,129 |

| AK06A | |
|---|---------|
| FEATURES & SPECIFICATIONS | PRICE |
| <ul style="list-style-type: none"> • Composite tray, reversible mouse tray, wrist rest & wire guide • KBSS mechanism extends above and below desk • Finish: black only | \$1,688 |

| AK09A | |
|--|-------|
| FEATURES & SPECIFICATIONS | PRICE |
| <ul style="list-style-type: none"> • Composite tray, reversible mouse tray, wrist rest & wire guide • Finish: black only | \$725 |

| AK10A | |
|--|---------|
| FEATURES & SPECIFICATIONS | PRICE |
| <ul style="list-style-type: none"> • Keyboard platform with wrist rest • Rear surface radiused for 12" corners • Finish: black only | \$1,206 |

| AK11A | |
|--|-------|
| FEATURES & SPECIFICATIONS | PRICE |
| <ul style="list-style-type: none"> • Keyboard platform with wrist rest • Rear surface has notched corners to fit 18" diagonal corner • Finish: black only | \$830 |

| AK12A | |
|---|---------|
| FEATURES & SPECIFICATIONS | PRICE |
| <ul style="list-style-type: none"> • 27" Wide rectangular laminate tray with vinyl wrist rest • KBSS mechanism extends above and below desk • Finish: black only | \$1,028 |



| ORDER CODE SAMPLE |
|--------------------------|
| ITEM CODE |
| AK10A |

Keyboard Platforms

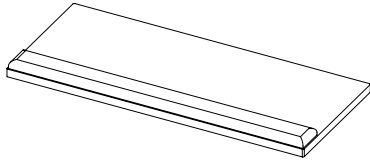

RECTANGULAR PLATFORM WITH WRIST REST

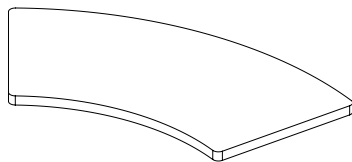

CURVED PLATFORM WITH WRIST REST

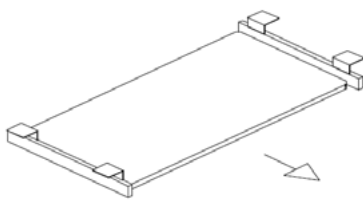

RETRACTABLE KEYBOARD TRAY

| ORDER CODE | SIZE | |
|------------|-------|-------|
| MODEL | WIDTH | PRICE |
| AKBTA | 20 | \$216 |
| AKBTA | 26 | \$288 |
| AKBTA | 27 | \$288 |
| AKBTA | 28 | \$288 |
| AKBTA | 30 | \$297 |

FEATURES & SPECIFICATIONS

- Upholstered vinyl padded wrist rests available in black only
- Laminate keyboard constructed of 0.75" LPL
- Includes mounting inserts on underside
- Laminate tray available in black only
- Depth is 12"

| ORDER CODE | SIZE | LAMINATE | | | |
|------------|-------|----------|--------|----------|----------|
| MODEL | WIDTH | DEPTH | RADIUS | PRICE M1 | PRICE H1 |
| AKBCA | 28 | 16.5 | 18 | \$228 | 282 |
| AKBCA | 30 | 16 | 24 | \$228 | 282 |

FEATURES & SPECIFICATIONS

- Designed to fit all BRC curved corner with same radius
- Includes mounting inserts on underside
- Laminate tray available in black only
- For straight front keyboard, add 'SF' to code
- Laminate keyboard constructed of 1" LPL or 1" HPL

| ORDER CODE | SIZE | |
|------------|-------|-------|
| MODEL | WIDTH | PRICE |
| AKBRA | 21 | \$155 |
| AKBRA | 28 | \$155 |

FEATURES & SPECIFICATIONS

- Retractable tray with lock out feature
- Laminate keyboard constructed of 0.75" LPL
- Fixed height clearance user defined during installation
- Can be installed under minimum 20" deep worksurface
- Laminate tray available in black only
- Depth is 12"



| ORDER CODE SAMPLE | |
|-------------------|------|
| ITEM CODE | SIZE |
| AKBRA | 28" |

PRODUCT MAP
ELECTRICAL
WIRE MANAGEMENT
UNDER DESK STORAGE
TASK LIGHTS
DESK SCREENS
CONTROLLER
GROMMETS
KEYBOARD COMBOS
CPU HOLDERS
MONITOR ARMS
KEYS
HOOKS
BRACKETS

Keyboard Mechanisms

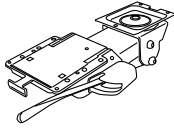

**HEIGHT ADJUSTABLE
KEYBOARD MECHANISM**

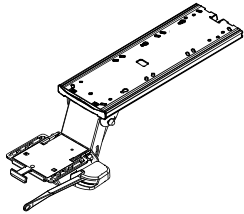

**HEAVY DUTY KEYBOARD
MECHANISM**

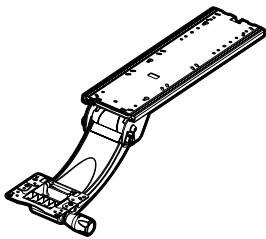

**HEAVY DUTY KEYBOARD
MECHANISM 2**

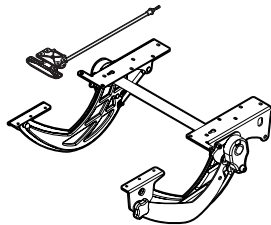

**HEAVY DUTY PADDLE
ADJUSTABLE DOUBLE
ARM KEYBOARD TRAY**

| ORDER CODE | SIZE | |
|------------|-------------|-------|
| MODEL | WEIGHT/CUBE | PRICE |
| AKM1A | 8/1.0 | \$536 |

FEATURES & SPECIFICATIONS

- Non retractable & height adjustable for worksurfaces of all depths
- 6" Height adjustment using lever lock actuator
- Easy pull tab activates tray tilt feature
- 15 Degrees positive or 10 degrees negative tray tilt

| ORDER CODE | SIZE | | |
|------------|-------------|------|-------|
| MODEL | WEIGHT/CUBE | Size | PRICE |
| AKM2A | 11/1.5 | 22 | \$679 |
| AKM2A | 11/1.5 | 17 | \$679 |

FEATURES & SPECIFICATIONS

- Fully retractable low profile support mechanism
- 24" Minimum worksurface depth required
- 6" Height adjustment using lever lock actuator
- Easy pull tab activates tray tilt feature
- 15 Degrees positive or 10 degrees negative tray tilt
- Steel ball bearing slide mechanism

| ORDER CODE | SIZE | |
|------------|-------------|---------|
| MODEL | WEIGHT/CUBE | PRICE |
| AKM3A | 11/1.5 | \$1,120 |

FEATURES & SPECIFICATIONS

- Fully retractable low profile support mechanism
- 24" Minimum worksurface depth required
- 6" Height adjustment using lever lock actuator
- Easy pull tab activates tray tilt feature
- 15 Degrees positive or 10 degrees negative tray tilt
- Steel ball bearing slide mechanism

| ORDER CODE | SIZE | | |
|------------|-------|-------|---------|
| MODEL | WIDTH | DEPTH | PRICE |
| AKM4A | 23 | 20 | \$835 |
| AKM4A | 27 | 20 | \$1,112 |

FEATURES & SPECIFICATIONS

- Includes 0.75" LPL black tray

OPTIONAL EXTRA

- Matching laminate available; specify on order and add \$250

▽

| ORDER CODE SAMPLE | |
|-------------------|------|
| ITEM CODE | SIZE |
| AKM4A | 23" |

Keyboard Corner and Spacers

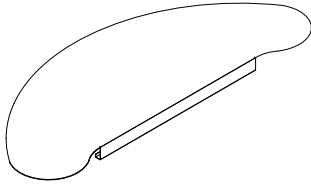

METAL KEYBOARD CORNER

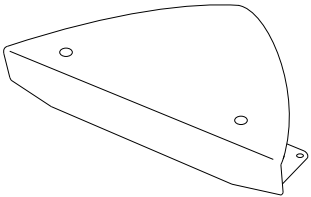

METAL FIXED KEYBOARD CORNER

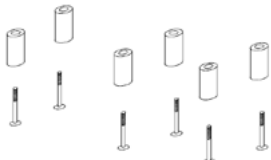

AKT1A & AKT2A



AKT3A

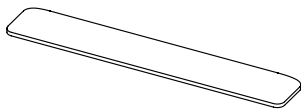

GEL WRIST REST

| ORDER CODE | | SIZE | |
|---|-------|-------|-------|
| MODEL | WIDTH | DEPTH | PRICE |
| AULUA | 41.5 | 16.5 | \$244 |
| FEATURES & SPECIFICATIONS | | | |
| <ul style="list-style-type: none"> Placed on top in the corner of the worksurface(s) Not intended for use with a keyboard mechanism Includes anti-slip/slide protection on underside Available in all standard BRC metal finishes | | | |

| ORDER CODE | | SIZE | |
|--|-------|-------|--|
| MODEL | WIDTH | PRICE | |
| AKVCA | 12 | \$253 | |
| FEATURES & SPECIFICATIONS | | | |
| <ul style="list-style-type: none"> Updates 90° workstations into corner workstations Accommodates worksurface thickness of 1.00" - 2.25" Black textured powdercoat finish Mounting hardware included | | | |

| ORDER CODE | | |
|--|---------------|-------|
| MODEL | SPACER HEIGHT | PRICE |
| AKT1A | 1.375 | \$53 |
| AKT2A | 2 | \$75 |
| AKT3A | 2 | \$110 |
| FEATURES & SPECIFICATIONS | | |
| <ul style="list-style-type: none"> Use AKT2A for Alta series tables; AKT1A for all other emotion tables; Includes 6 spacers and attaching hardware Use AKT3A for Mesa series tables; includes 2 brackets All KBW series mechanisms require a 2" spacer kit when installed on Emotion height adjustable products | | |

| ORDER CODE | | SIZE | |
|--|-------|-------|-------|
| MODEL | WIDTH | DEPTH | PRICE |
| AKW1A | 19 | 3 | \$162 |
| AKW2A | 27 | 3 | \$208 |
| FEATURES & SPECIFICATIONS | | | |
| <ul style="list-style-type: none"> Self tacking underside, black only | | | |

CPU Holders

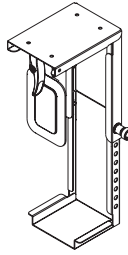

MINI FIXED MOUNT

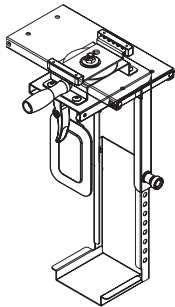

MINI SLIDE AND SWIVEL

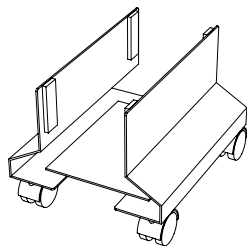

MOBILE CPU CART

| ORDER CODE | ACCOMMODATES CPU SIZE | | |
|------------|-----------------------|-------------|-------|
| MODEL | HEIGHT RANGE | WIDTH RANGE | PRICE |
| ACP1A | 7.9" - 14 | 2" - 4 | \$250 |

| FEATURES & SPECIFICATIONS | | | |
|--|--|--|--|
| <ul style="list-style-type: none"> • Finished in black textured powdercoat • Plastic side clamp with bumpers • Side mountable • Fixed unit; does not swivel or retract • Depth: 4.5" • Weight: 8.0 lbs • capacity: 22 lbs | | | |

| ORDER CODE | ACCOMMODATES CPU SIZE | | |
|------------|-----------------------|-------------|-------|
| MODEL | HEIGHT RANGE | WIDTH RANGE | PRICE |
| ACP2A | 3.9" - 14 | 2" - 4 | \$356 |

| FEATURES & SPECIFICATIONS | | | |
|--|--|--|--|
| <ul style="list-style-type: none"> • Finished in black textured powdercoat • Plastic side clamp with bumpers • Side mountable • Depth: 4.5" • Weight: 8.0 lbs • capacity: 22 lbs | | | |

| ORDER CODE | ACCOMMODATES CPU SIZE | |
|------------|-----------------------|-------|
| MODEL | WIDTH RANGE | PRICE |
| ACPMMA | 5.125" - 10 | \$254 |

| FEATURES & SPECIFICATIONS | | |
|--|--|--|
| <ul style="list-style-type: none"> • All metal construction • Elevates CPU off the floor • Adjustable width • Foam pads on each side cushion CPU • Finished in black only | | |

▽

| ORDER CODE SAMPLE |
|-------------------|
| ITEM CODE |
| ACP1A |

CPU Holders

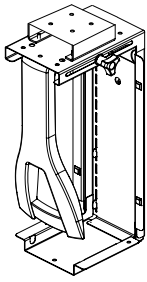

FULL SIZE FIXED MOUNT

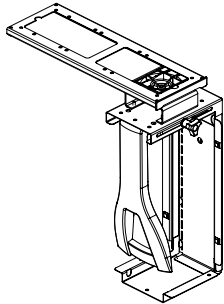

FULL SIZE SLIDE & SWIVEL

| ORDER CODE | | ACCOMMODATES CPU SIZE | |
|---|--------------|-----------------------|-------|
| MODEL | HEIGHT RANGE | WIDTH RANGE | PRICE |
| ACP3A | 14.5" - 22.5 | 3.5" - 9.3 | \$540 |
| FEATURES & SPECIFICATIONS | | | |
| <ul style="list-style-type: none"> • Finished in black textured powdercoat • Plastic side clamp with bumpers • Side mountable • Fixed unit; does not swivel or retract • Weight: 8.0 lbs • Capacity: 50 lbs | | | |

| ORDER CODE | | ACCOMMODATES CPU SIZE | |
|---|--------------|-----------------------|-------|
| MODEL | HEIGHT RANGE | WIDTH RANGE | PRICE |
| ACP4A | 14.5" - 22.5 | 3.5" - 9.3 | \$808 |
| FEATURES & SPECIFICATIONS | | | |
| <ul style="list-style-type: none"> • Finished in black textured powdercoat • Plastic side clamp with bumpers • Ball bearing track slide is 17" deep • 360° Swivel • Side mountable • Weight: 12.4 lbs • Capacity: 50 lbs | | | |



| ORDER CODE SAMPLE |
|-------------------|
| ITEM CODE |
| ACP4A |

Monitor Arms & TV Mounts

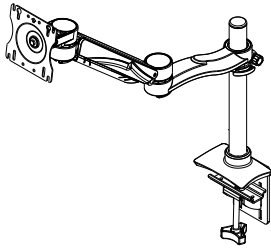

SINGLE MONITOR ARM

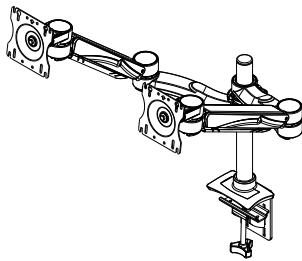

DUAL MONITOR ARM

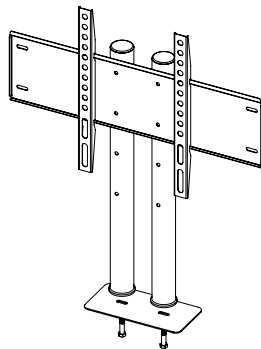

MEDIA TV MOUNT

| ORDER CODE | SIZE | |
|---|--------------|-------|
| MODEL | HEIGHT RANGE | PRICE |
| AMA1A | 12.4 | \$664 |
| FEATURES & SPECIFICATIONS | | |
| <ul style="list-style-type: none"> • Finished in silver powdercoat • 20lbs load capacity • Desk clamp and grommet mount hardware included • Integrated cable management • Vesa mount accommodates 75mm and 100mm hole patterns • Included allen wrench adjustment | | |

| ORDER CODE | SIZE | |
|--|--------------|---------|
| MODEL | HEIGHT RANGE | PRICE |
| AMA2A | 12.4 | \$1,152 |
| FEATURES & SPECIFICATIONS | | |
| <ul style="list-style-type: none"> • Finished in silver powdercoat • 20lbs load capacity per screen • Desk clamp and grommet mount hardware included • Integrated cable management • Vesa mount accommodates 75mm and 100mm hole patterns • Maximum 35" screen width • Included allen wrench adjustment | | |

| ORDER CODE | SIZE | |
|---|--------------|---------|
| MODEL | HEIGHT RANGE | PRICE |
| AMTVD | 16"-26.5 | \$1,030 |
| FEATURES & SPECIFICATIONS | | |
| <ul style="list-style-type: none"> • Finished in black powdercoat • 80lbs load capacity • Permanent table top mount only; requires two holes • Vesa mount accommodates 75mm, 100mm & 200mm hole patterns • Min screen 32" - max 65" diagonal screen width • 4 Adjustable height ranges: 16", 19.5", 23" & 26.5" | | |



| ORDER CODE SAMPLE | |
|-------------------|--------|
| ITEM CODE | FINISH |
| AMA2A | SILVER |

Hooks

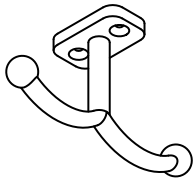

BAG HOOK

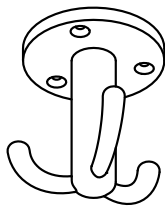

COAT HOOK

| ORDER CODE | | SIZE | | |
|--|--|-------|--------|-------|
| MODEL | | WIDTH | HEIGHT | PRICE |
| AHKBA | | 0.8 | 3.2 | \$57 |
| FEATURES & SPECIFICATIONS | | | | |
| <ul style="list-style-type: none"> • Chrome finish only • Material is metal • Accommodates maximum loading of 15 kg • Mounting hardware included | | | | |

| ORDER CODE | | SIZE | | |
|---|--|-------|--------|-----------|
| MODEL | | WIDTH | HEIGHT | PRICE |
| AHKCA | | 2.1 | 2.3" | \$67 \$71 |
| FEATURES & SPECIFICATIONS | | | | |
| <ul style="list-style-type: none"> • Polished aluminum • Mounting hardware included | | | | |



| ORDER CODE SAMPLE | |
|-------------------|--------|
| ITEM CODE | FINISH |
| AHKBA | CHROME |

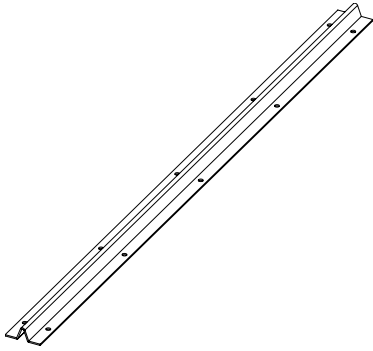

| AACVA | |
|---|-------|
| SIZE | PRICE |
| 54 | \$135 |
| FEATURES & SPECIFICATIONS | |
| <ul style="list-style-type: none"> • For use with extended unsupported worksurface lengths • Includes 3/4" self tapping wood screws • Black only | |



| |
|--------------------------|
| ORDER CODE SAMPLE |
| ITEM CODE |
| AACVA |

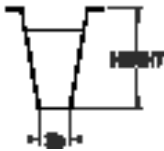
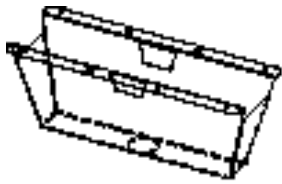

Features & Specifications

No Charge Options

| ORDER CODE | | | |
|------------|--------|--------|-------|
| SIZE | HEIGHT | LENGTH | PRICE |
| 5.625 | 5.625 | 16 | \$232 |
| 6 | 6 | 16 | \$258 |

| APPLICATION CHART | | |
|--------------------|--------------------------------------|---|
| BRC STORAGE HEIGHT | SPACER FOR 29" HIGH DESK WITH 1" TOP | SPACER FOR 29" HIGH DESK WITH 0.75" TOP |
| 21.25" | 5.625" | 6" |



| ORDER CODE SAMPLE | |
|-------------------|-------|
| ITEM CODE | SIZE |
| AACSA | 5.625 |

- Mounts using screws to underside and double sided tape (included) to base
- 1.75" Hole at base allows for wire pass through; cabinet must be drilled on site if required
- 0.75" Long Screws provided

- All standard metal finishes available

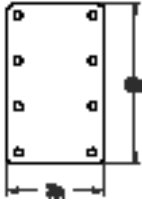

| AAFLA | |
|---|-------|
| SIZE | PRICE |
| 3" x 5 | \$70 |
| FEATURES & SPECIFICATIONS | |
| <ul style="list-style-type: none"> • Used to support worksurfaces to adjacent furniture • Kit includes two 3" x 5" brackets and 3/4" self tapping wood screws • Black powdercoat finish only | |



| |
|--------------------------|
| ORDER CODE SAMPLE |
| ITEM CODE |
| AAFLA |

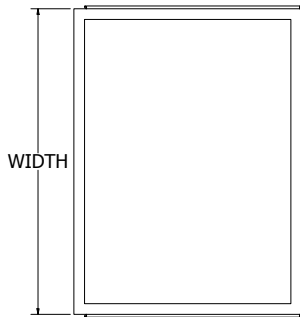
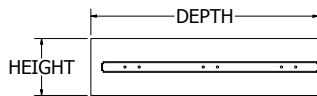
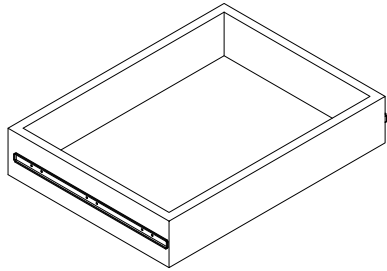

| OVERALL SIZE | | |
|--------------|--------|-------|
| WIDTH | HEIGHT | PRICE |
| 13 | 3 | \$228 |
| 15.45 | 3 | \$231 |
| 21.45 | 3 | \$243 |
| 27.45 | 3 | \$255 |
| 33.45 | 3 | \$265 |
| 39.45 | 3 | \$271 |
| 13 | 4 | \$228 |
| 15.45 | 4 | \$231 |
| 21.45 | 4 | \$243 |
| 27.45 | 4 | \$255 |
| 33.45 | 4 | \$265 |
| 39.45 | 4 | \$271 |
| 13 | 10 | \$273 |
| 15.45 | 10 | \$280 |
| 21.45 | 10 | \$289 |
| 27.45 | 10 | \$305 |
| 33.45 | 10 | \$317 |
| 39.45 | 10 | \$326 |

Features & Specifications



| ORDER CODE SAMPLE | | |
|-------------------|-------|--------|
| ITEM CODE | WIDTH | HEIGHT |
| AQBBA | 15.45 | 4 |

- Intended for drawer box & file replacement only, not for new installations
- Dimensions are exact; measure existing drawer to obtain correct size
- All boxes have a depth of 16" regardless of width or height
- All replacement boxes include mounted slides and top frames to accommodate hanger bars
- Box drawers are black laminate finish
- Does not include drawer front or handle if applicable

Special Notes

- Replacement drawer applies to standard product only. Many custom products are created using standard size drawer boxes. Measure existing drawer to confirm replacement size.

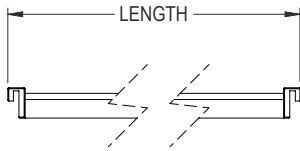
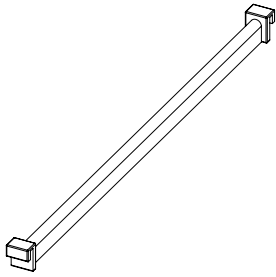

AQFFA

| LENGTH | PRICE |
|--------|-------|
| 12 | \$70 |
| 14 | \$70 |

FEATURES & SPECIFICATIONS

- Use 12" for letter (side to side) and 14" for legal size (front to back) paper
- Will fit all standard BRC drawer boxes
- Price includes set of two
- Black powdercoat & plastic finish only



| |
|--------------------------|
| ORDER CODE SAMPLE |
| ITEM CODE |
| AQFFA |

| |
|--------------------|
| PRODUCT MAP |
| ELECTRICAL |
| WIRE MANAGEMENT |
| UNDER DESK STORAGE |
| TASK LIGHTS |
| DESK SCREENS |
| CONTROLLER |
| GROMMETS |
| KEYBOARD COMBOS |
| CPU HOLDERS |
| MONITOR ARMS |
| KEYS |
| HOOKS |
| BRACKETS |



BRC MASTER KEY

| AKYMA | |
|--|-------|
| FEATURES & SPECIFICATIONS | PRICE |
| <ul style="list-style-type: none"> • Can be used to open all standard BRC CL series locks • Key handle is blue | \$63 |



BRC REMOVAL KEY

| AKYRA | |
|---|-------|
| FEATURES & SPECIFICATIONS | PRICE |
| <ul style="list-style-type: none"> • Can be used to remove the lock core from any standard BRC CL series lock housing • Key handle is red | \$63 |



BRC SINGLE LOCK CORE

| AKY1A | |
|--|-------|
| FEATURES & SPECIFICATIONS | PRICE |
| <ul style="list-style-type: none"> • Single lock set including lockcore & two keys • CL series • If not specified random numbers between 500 and 509 will be assigned • Alternatively specific lock numbers can be ordered from number 551-700 • Color options: black or silver | \$63 |



BRC SINGLE CAM LOCK WITH HOUSING

| AKY2A | |
|--|-------|
| FEATURES & SPECIFICATIONS | PRICE |
| <ul style="list-style-type: none"> • Single lock set including lockcore, housing with cam & two keys • CL series • If not specified random numbers between 500 and 509 will be assigned • Alternatively specific lock numbers can be ordered from number 551-700 • Color options: black or silver | \$63 |

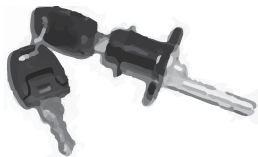

BRC SINGLE LOCK WITH HOUSING FOR DRAWERS

| AKY3A | |
|---|-------|
| FEATURES & SPECIFICATIONS | PRICE |
| <ul style="list-style-type: none"> • Single lock set including lockcore, housing with cam & two keys • Housing fits brc standard drawers • CL series • If not specified random numbers between 500 and 509 will be assigned • Alternatively specific lock numbers can be ordered from number 551-700 • Color options: black or silver | \$63 |



| ORDER CODE SAMPLE | |
|-------------------|--------|
| ITEM CODE | FINISH |
| AKY2A | SILVER |



HUDSON MASTER KEY

| AKHMA | |
|--|-------|
| FEATURES & SPECIFICATIONS | PRICE |
| <ul style="list-style-type: none"> • Can be used to open all standard Hudson series locks • Key handle is blue | \$63 |



HUDSON REMOVAL KEY

| AKHRA | |
|---|-------|
| FEATURES & SPECIFICATIONS | PRICE |
| <ul style="list-style-type: none"> • Can be used to remove the lock core from any standard Hudson series lock housing • Key handle is red | \$63 |



HUDSON SINGLE LOCK CORE

| AKH1A | |
|---|-------|
| FEATURES & SPECIFICATIONS | PRICE |
| <ul style="list-style-type: none"> • Single lock set including lockcore & one key • Hudson series • If not specified random numbers between 226 and 235 will be assigned • Alternatively specific lock numbers can be ordered from number 250-349 • Color options: black or silver | \$63 |



HUDSON SINGLE CAM LOCK WITH HOUSING

| AKH2A | |
|---|-------|
| FEATURES & SPECIFICATIONS | PRICE |
| <ul style="list-style-type: none"> • Single lock set including lockcore, housing with cam & one key • Hudson series • If not specified random numbers between 226 and 235 will be assigned • Alternatively specific lock numbers can be ordered from number 250-349 • Color options: black or silver | \$63 |

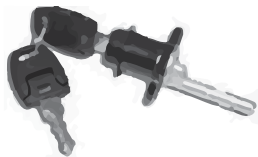

HUDSON SINGLE LOCK WITH HOUSING FOR DRAWERS

| AKH3A | |
|--|-------|
| FEATURES & SPECIFICATIONS | PRICE |
| <ul style="list-style-type: none"> • Single lock set including lockcore, housing with cam & one key • Housing fits BRC standard drawers • Hudson series • If not specified random numbers between 226 and 235 will be assigned • Alternatively specific lock numbers can be ordered from number 250-349 • Color options: black or silver | \$63 |



| ORDER CODE SAMPLE | |
|--------------------------|--------|
| ITEM CODE | FINISH |
| AKH2A | SILVER |

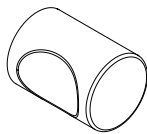
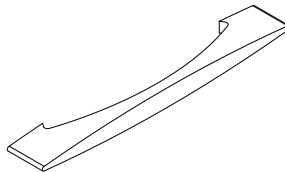
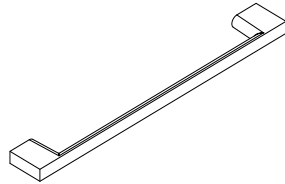
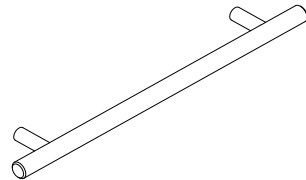
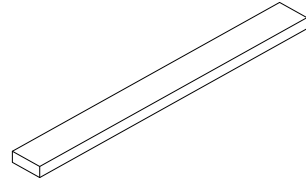
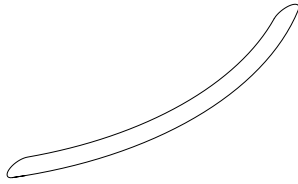

| AQCRA | |
|---|-------|
| FEATURES & SPECIFICATIONS | PRICE |
| <ul style="list-style-type: none"> • Curve handle • Available in silver and black • Includes mounting hardware | \$76 |

| AQFLA | |
|---|-------|
| FEATURES & SPECIFICATIONS | PRICE |
| <ul style="list-style-type: none"> • Flat bar handle • Available in silver, black, white and chrome • Includes mounting hardware | \$76 |

| AQHBA | |
|---|-------|
| FEATURES & SPECIFICATIONS | PRICE |
| <ul style="list-style-type: none"> • H-Bar handle • Available in brushed nickel and black • Includes mounting hardware | \$76 |

| AQNVA | |
|--|-------|
| FEATURES & SPECIFICATIONS | PRICE |
| <ul style="list-style-type: none"> • Nova handle • Available in brushed nickel • Includes mounting hardware | \$76 |

| AQSTA | |
|--|-------|
| FEATURES & SPECIFICATIONS | PRICE |
| <ul style="list-style-type: none"> • Stylus handle • Available in matte chrome • Includes mounting hardware | \$76 |

| AQLKA | |
|---|-------|
| FEATURES & SPECIFICATIONS | PRICE |
| <ul style="list-style-type: none"> • Locker handle • Available in chrome and matte chrome • Includes mounting hardware | \$76 |

▽

| ORDER CODE SAMPLE | |
|--------------------------|--------|
| ITEM CODE | FINISH |
| AQCRA | BLACK |

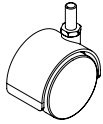

**THREADED STEM CASTER
NON-LOCKING**

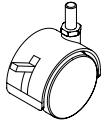

**THREADED STEM CASTER
LOCKING**

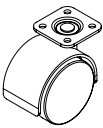

**PLATE MOUNT CASTER
NON-LOCKING**

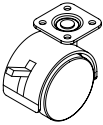

**PLATE MOUNT CASTER
LOCKING**

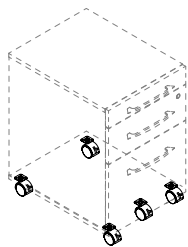

**MOBILE CASTER
REPLACEMENT KIT**

| AQCTA | |
|---|--------------|
| FEATURES & SPECIFICATIONS | PRICE (each) |
| <ul style="list-style-type: none"> • 5/16" Thread • Intended for replacement of standard BRC threaded stem caster • 2.5" Overall height (minus thread) • Black plastic finish | \$59 |

| AQCSA | |
|---|--------------|
| FEATURES & SPECIFICATIONS | PRICE (each) |
| <ul style="list-style-type: none"> • 5/16" Thread • Intended for replacement of standard BRC locking threaded stem caster • 2.5" Overall height (minus thread) • Black plastic finish | \$59 |

| AQCPA | |
|--|--------------|
| FEATURES & SPECIFICATIONS | PRICE (each) |
| <ul style="list-style-type: none"> • Intended for replacement of standard BRC plate mount caster • 2.5" Overall height • Black plastic finish and zinc coated top plate | \$59 |

| AQCLA | |
|--|--------------|
| FEATURES & SPECIFICATIONS | PRICE (each) |
| <ul style="list-style-type: none"> • Intended for replacement of standard BRC locking plate mount caster • 2.5" Overall height • Black plastic finish and zinc coated top plate | \$59 |

| AQCKA | |
|--|-----------------|
| FEATURES & SPECIFICATIONS | PRICE (per kit) |
| <ul style="list-style-type: none"> • Intended for replacement of standard BRC mobile pedestal casters • Includes 5 locking casters • Black plastic finish | \$188 |

▽

| ORDER CODE SAMPLE |
|-------------------|
| ITEM CODE |
| AQCKA |



SWIVEL SKATE CASTER



SWIVEL SKATE CASTER WITH BRAKE



PLATE SKATE CASTER



PLATE SKATE CASTER WITH BRAKE

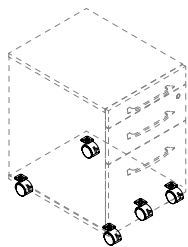

SKATE CASTER REPLACEMENT KIT

| ASKCN | |
|---|--------------|
| FEATURES & SPECIFICATIONS | PRICE (each) |
| <ul style="list-style-type: none"> • Caster 2" Dia 3/8-16 x 1" Swivel ICE No Brake • Use with Viva 2 Leg height adjustable tables • 2" Dia Caster no brake • Clear caster | \$66 |

| ASKCB | |
|---|--------------|
| FEATURES & SPECIFICATIONS | PRICE (each) |
| <ul style="list-style-type: none"> • Caster 2" Dia 3/8-16 x 1" Swivel ICE With Brake • Use with Viva 2 Leg height adjustable tables • 2" Dia Caster with brake • Clear caster | \$66 |

| ASKPN | |
|--|--------------|
| FEATURES & SPECIFICATIONS | PRICE (each) |
| <ul style="list-style-type: none"> • Caster 2" Dia Swivel ICE A17D Plate No brake • Plate Caster No Brake • 2" Dia Caster overall height 2-5/8" • Clear caster | \$66 |

| ASKPB | |
|--|--------------|
| FEATURES & SPECIFICATIONS | PRICE (each) |
| <ul style="list-style-type: none"> • Caster 2" Dia Swivel ICE A17D Plate With brake • Plate Caster With Brake • 2" Dia Caster overall height 2-5/8" • Clear caster | \$66 |

| ASKKA | |
|---|-----------------|
| FEATURES & SPECIFICATIONS | PRICE (per kit) |
| <ul style="list-style-type: none"> • Intended for replacement of brc mobile ped casters • Includes 2 locking, 2 non locking and 1 thread stem • Clear caster | \$207 |

▽

| ORDER CODE SAMPLE |
|-------------------|
| ITEM CODE |
| ASKKA |

Mesa T Leg Foot with Caster

AQMFM

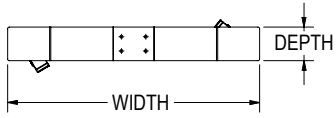
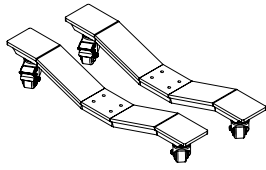

| ACTUAL SIZE | | |
|-------------|-------|-------|
| WIDTH | DEPTH | PRICE |
| 23.75 | 3.25 | \$281 |

Features & Specifications

No Charge Options



| ORDER CODE SAMPLE |
|-------------------|
| ITEM CODE |
| AQMFM |

- Kit includes one pair of feet with casters
- Includes twin wheel casters
- Used for two leg T configurations only
- Adjusted height range with BIFMA column: 23" to 48.25"

- Available in standard metal paint finishes

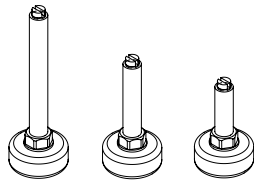

LEVELER

| AQLLA | |
|---|---------------------|
| LENGTH | PRICE (each) |
| 1 | \$48 |
| 1.5 | \$48 |
| 2.5 | \$48 |
| FEATURES & SPECIFICATIONS | |
| <ul style="list-style-type: none"> • 5/16" Thread • Intended for replacement of standard BRC leveler • Size indicates thread length • Black plastic and zinc coated thread stem | |



| ORDER CODE SAMPLE | |
|--------------------------|-------------|
| ITEM CODE | SIZE |
| AQLLA | 1.00 |

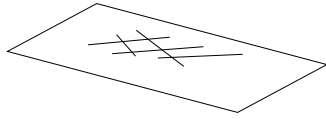

| OVERALL SIZE | | | |
|--------------|-------|---------------------|-------|
| WIDTH | DEPTH | DESIGNED FOR LOCKER | PRICE |
| 10.5 | 13.5 | _LCKX | \$188 |
| 13.5 | 13.5 | _LCKX | \$188 |
| 16 | 13.5 | _LCKX | \$188 |
| 18.5 | 13.5 | _LCKX | \$188 |
| 11 | 16.5 | _LCAX, _LCCX | \$204 |
| 17 | 16.5 | _LCAX, _LCCX | \$204 |
| 23.5 | 16.5 | _LCTX | \$232 |
| 34.5 | 16.5 | _LCTX | \$249 |
| 10.5 | 18.5 | _LCKX | \$204 |
| 13.5 | 18.5 | _LCKX | \$204 |
| 18.5 | 18.5 | _LCKX | \$204 |
| 10.5 | 23.5 | _LCKX | \$215 |
| 13.5 | 23.5 | _LCKX | \$215 |
| 18.5 | 23.5 | _LCKX | \$215 |



| ORDER CODE SAMPLE | | |
|-------------------|-------|-------|
| ITEM CODE | WIDTH | DEPTH |
| AQBTA | 12 | 18 |

Features & Specifications

- Boot liner can be cut on site to fit if required
- Not available with raised edges
- Sizes listed are 1/4" less overall to account for expansion and contraction
- For custom sizes, indicate actual size required

No Charge Options

- All standard metal finishes available

Connect Ganging Table Bracket Set

AGNGA

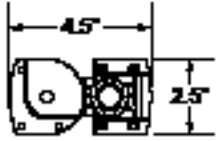

| NOMINAL SIZE | | | |
|--------------|-------|--------|-------|
| WIDTH | DEPTH | HEIGHT | PRICE |
| 4.5 | 2.5 | 1.5 | \$48 |



| ORDER CODE SAMPLE |
|-------------------|
| ITEM CODE |
| AGNGA |

Features & Specifications

- No tools required for operation after installation
- Includes one set as shown
- Finished in black

Daisy Chain Power Module Accessories

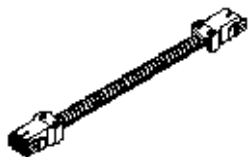
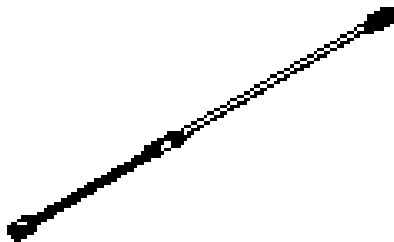
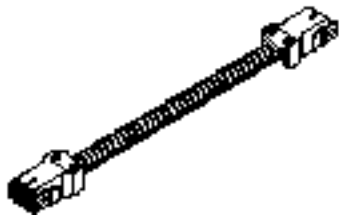

Features & Specifications

| ORDER CODE | | |
|------------|--------|-------|
| MODEL | LENGTH | PRICE |
| ADFFE | 36 | \$165 |
| ADFFE | 42 | \$175 |
| ADFFE | 48 | \$186 |
| ADFFE | 54 | \$196 |
| ADFFE | 58 | \$201 |
| ADFFE | 64 | \$213 |
| ADFFE | 70 | \$224 |

| FEATURES & SPECIFICATIONS |
|---|
| <ul style="list-style-type: none"> Female/Female interconnecting cable |

| ADPIE | |
|--|-------|
| FEATURES & SPECIFICATIONS | PRICE |
| <ul style="list-style-type: none"> Power infeed 3 prong - single circuit Length: 72" | \$319 |

| ADFNE | |
|--|-------|
| FEATURES & SPECIFICATIONS | PRICE |
| <ul style="list-style-type: none"> Female/Male interconnecting cable extension Length: 36" | \$210 |



| ORDER CODE SAMPLE |
|-------------------|
| ITEM CODE |
| ADFNE |

- Metal shielded cables

For sales information contact: quotes@brc.group

24 Armstrong Ave
Georgetown, ON L7G 4R9
Phone: 905.873.8509
Toll Free: 1.877.260.4309
info@brc.group

