

EMOTION

Price Guide - 2025 R1



Product Map

- Mesa Electric Height Adjustable
- Viva Electric Height Adjustable
- Manually Operated Height Adjustable
- Incremental Height Adjustable Tables
- Fixed Height Tables
- SoHo Electric Height Adjustable
- NoLita Electric Height Adjustable
- Controller Options
- HA Support Bracket
- HAT Accessories



Contents

Welcome	2
Guidance and Ordering	4
File Drawers	5
Counterweights	6
Product Safety	7
Cleaning & Maintenance	8
Standard & Custom Sizing	9
Contents	11
Product Map	12
Products	13
HAT Accessories	79

www.brc.group	PRODUCT MAP
CONTROLLERS	TABLE OF CONTENTS
NOLITA	MESA ELECTRIC
SOHO	VIVA ELECTRIC
VIVA FIXED HEIGHT	VIVA MANUAL
VIVA INCREMENTAL	VIVA ELECTRIC
VIVA ELECTRIC	MESA ELECTRIC
VIVA MANUAL	TABLE OF CONTENTS
VIVA INCREMENTAL	PRODUCT MAP
VIVA FIXED HEIGHT	TABLE OF CONTENTS
SOHO	TABLE OF CONTENTS
NOLITA	TABLE OF CONTENTS
CONTROLLERS	TABLE OF CONTENTS
www.brc.group	TABLE OF CONTENTS

Thank you for choosing BRC

Established in 1979 and incorporated in 1983, BRC Group has grown into a leader in the research, development and manufacturing of high quality ergonomic office furniture. BRC is a Canadian-owned private company with modern manufacturing facilities in Georgetown, Ontario, Canada.

BRC is a forerunner in blending environmental initiatives with the manufacturing of renewable and recyclable products. BRC uses materials and manufacturing processes which virtually eliminate Volatile Organic Chemical (VOC) emissions in the office environment. Raw materials are responsibly sourced, assuring that only the best and most sustainable components are converted to finished goods. BRC is committed to developing and offering the best-value products for the middle and higher end markets.

From OEM solutions to obscure designer requests to simply striving to be better, BRC provides creative and innovative customized solutions to complement any environment and use. Flexible manufacturing offers the ability for BRC to respond to client's special needs rather than having standard catalogue solutions. A wide collection of textiles and laminate finishes allows companies and individuals to express their brand and culture through a unique signature look.

All furniture is designed and manufactured to meet or exceed ANSI-BIFMA standards. Standard construction uses a combination of 3/4" and 1" material and metal to metal commercial grade connections for solid enduring assembly. The newest edge banding technology, in which the edge tape is melted directly to the edge of the board, enables BRC to manufacture products with virtually invisible glue lines.

The BRC Team works hard to earn and keep your business - our success depends on it. If you have any questions or inquires, please contact us at info@brc.group or toll free at 1-877-260-4309.

We appreciate your business and look forward to hearing from you.

Warranty, Terms & Conditions

BRC is pleased to offer one of the most competitive warranties in the industry. All furniture products carry a 12 year limited structural warranty. BRC furniture panel and table electrical cabling carry a 3 year limited warranty. All moving user adjustable components carry a 5 year limited structural warranty. All other electrical or electronic elements of BRC furniture carry a 1 year limited warranty.

For full warranty details, terms and conditions, please visit www.brc.group/warranty

Shipping Rates & Policies

Emotion product should be assumed to ship knocked down. Assembly of the worksurface to the base frame and the frame foot to the base frame assembly will be required on Viva product. Mesa product will be shipped with the worksurface separate and be accompanied by one box for a 2 leg table, and two boxes for a 3 leg table. Assembly instructions are included in the box or available for download on our website at www.brc.group/installation

Shipping costs are calculated based on net order value and destination. In many cases, the freight cost may be included in your order. For detailed information, visit our website at www.brc.group/freight

Emotion Height Adjustable Tables

BRC's Emotion series is a tested and proven height adjustable solution both in the lab and in the field. The product has sustained over 20 years of success and during that time undergone constant refinements and improvements. Rugged construction and reliable electronic components have been tested and certified to ANSI BIFMA & CGSB standards assuring the highest quality.



A Workstation for Everyone

Stationary desks and workstations present a problem to natural instinct. The human body is designed to benefit from motion which is important for spinal health, improving circulation and reducing muscle fatigue. Height adjustable tables can encourage movement by offering the user multiple sitting and standing positions.

Another benefit is the ability for the user to adjust the desk to the optimal working height for their body both in a sitting and standing position. Even two people who are the same height may have different resting elbow positions and in turn prefer different sitting and standing heights. The benefit is that a workstation can accommodate virtually all users at a cost that is only marginally higher than a fixed height desk providing users an opportunity to break their static posture without leaving the work area.

Height adjustable tables can also provide an inclusive atmosphere for everyone. BRC's line of Mesa and Viva height adjustable electric desks provide a modestly free ADA solution that is wheelchair accessible. In addition, these product lines offer a collision free mechanism that stops table movement when resistance is encountered, preventing injury.

Guidance & Ordering

PRODUCT NAME & DESCRIPTION → Viva 2 Leg Electric Table

ACTUAL SIZE IN INCHES →

WEIGHT IN LBS & CUBIC FT →

ALL PRICES IN LIST →

PRODUCT CODE → MWEE

LAMINATE OPTIONS (ACTUAL THICKNESS in/mm):
 M1 - 1" THICK LPL (1.016"/25.8mm)
 H1 - 1" THICK HPL (1.063"/27.0mm)
 K1 - 1.25" THICK HPL KNIFE EDGE (1.339"/34mm)

HYPERLINK TO OTHER ITEMS WITHIN DOCUMENT

USE THIS EXAMPLE AS A GUIDE TO ORDER. ENTER OPTION AS REQUIRED.

DESCRIPTION OF FEATURES AND INCLUDED ITEMS

OPTIONS AND FEATURES AVAILABLE AT NO EXTRA CHARGE

OPTIONS OR FEATURES AVAILABLE BUT AT ADDITIONAL CHARGE. ADD CODE WHERE APPLICABLE AND ADDITIONAL PRICE TO TOTAL

ACTUAL SIZE		LAMINATE		
WIDTH	DEPTH	WEIGHT/CUBE	PRICE M1	PRICE H1
82"	35"	120/72	2,987	3,021
82"	29"	120/72	2,646	2,680
76"	29"	110/72	2,521	2,561
70"	29"	110/72	2,384	2,425
64"	29"	110/60	2,384	2,425
58"	29"	110/60	2,215	2,344
46"	29"	105/48	2,215	2,248
40"	29"	95/48	2,101	2,140
34"	29"	85/36	2,101	2,113
28"	29"	70/30	2,045	2,084
94"	23"	143/30	2,987	3,021
82"	23"	120/30	2,533	2,567
76"	23"	110/30	2,407	2,447
70"	23"	115/72	2,271	2,311
64"	23"	105/60	2,181	2,231
58"	23"	100/48	2,101	2,135
46"	23"	90/48	1,988	2,027
40"	23"	80/36	1,965	1,998
34"	23"	70/30	1,930	1,970
28"	23"	70/30	1,920	1,959

ORDER CODE SAMPLE

ITEM CODE	WIDTH	DEPTH	LAMINATE	SCULPTURE	OPTION
MWEE	70	23	H1	SN	LMP

Features & Specifications

- Leg provides 1" of leveling
- Laminate codes - M1: 1" LPL, H1: 1" HPL (top only)
- Specify sculpture - SN - none, SR - right, SL - left, or SD - double
- Woodgrain runs horizontally if applicable
- Sculpture is 6" deep (eg: 23" depth is 17" at edge when sculptured)

No Charge Options

- Available in all standard laminates
- Available in standard metal paint finishes
- For sizes not listed, specify actual (not nominal) size in product code

Optional Extra

- Specify GL (left), GC (center) and/or GR (right) for grommet; add \$56 per grommet
- Specify LMP for laminate modesty panel; add \$126 for tables 48" wide or less and \$205 for tables over 48" wide
- 6" Bow fronts for tables 58" and larger available; add BF to code and \$158

PRODUCT →

SIZE →

LAMINATE OPTION →

HANDED OPTION →

ADDITIONAL OPTIONS →

ORDER CODE SAMPLE

ITEM CODE	WIDTH	DEPTH	LAMINATE	SCULPTURE	OPTION
MWEE	70	23	H1	SN	LMP

DARKER GREY BOXES CONTAIN CODE DESCRIPTIONS

WHITE BOXES INDICATE EXTRA OPTIONS NOT MANDATORY FOR ORDERING. FOR DEFAULT OR NO OPTIONS, LEAVE BLANK

LIGHT GREY BOXES INDICATE MANDATORY SELECTION FOR ORDERING

ITALICS INDICATE PRODUCT OPTIONS

PURCHASE ORDER LINE ITEM FOR ABOVE: MWEE 70 23 H1 SN LMP

File Drawers

Load Considerations

Filing drawers can be one of the most convenient storage items in the office environment. Careful consideration must be paid to how the drawers are loaded, how much load and when to secure the cabinet to an additional support structure. File drawers must always be loaded from the bottom first. This puts the center of gravity lower and reduces the tipping hazard. Depending on application, cabinets should be secured to adjacent cabinets, a wall or another support structure for additional assurance. All drawer cabinets can be susceptible to tipping so careful planning is essential for prevention. Contact your BRC representative for more information.

Look for this warning label placed inside all file drawers manufactured by BRC

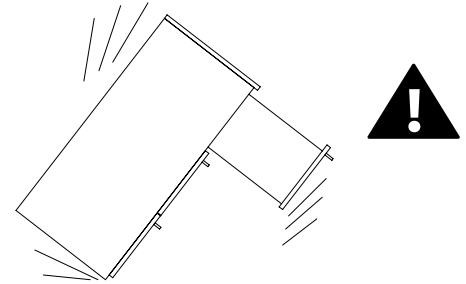
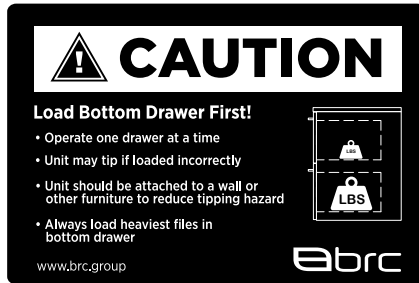

Capacity & Filing Options

BRC File drawers can accommodate letter and legal hanging file folders. Standard size file drawers in 30", 36" & 42" widths include two side to side hanging bars and two front to back hanging bars (24" wide drawers include only one of each). The side to side hanging bar can be positioned to fit letter and legal files. The front to back hanging bars can be positioned to accommodate two rows front to back of letter and legal depending on drawer width. Pedestal file drawers include one side to side hanging bar that can be positioned to accommodate letter and legal side to side. Pedestal file drawers can accommodate letter only front to back.

STANDARD SIZE FILE DRAWER CAPACITY			
NOMINAL WIDTH	INTERIOR WIDTH	INTERIOR DEPTH	MAXIMUM LOAD (LBS)*
24"	20.4"	15.14"	55
30"	26.4"	15.14"	72
36"	32.4"	15.14"	90

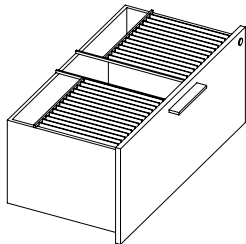

FILE RAILS ACCOMMODATE LEGAL SIDE TO SIDE; FILE BARS CAN BE USED TO ACCOMMODATE LETTER SIDE TO SIDE

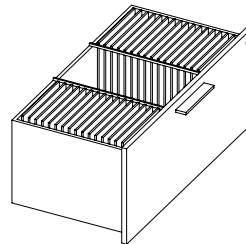

FRONT TO BACK BARS POSITIONED TO ACCOMMODATE LETTER OR LEGAL

PEDESTAL FILE DRAWER CAPACITY			
NOMINAL WIDTH	INTERIOR WIDTH	INTERIOR DEPTH	MAXIMUM LOAD (LBS)*
15.75"	11.9"	15.14"	33

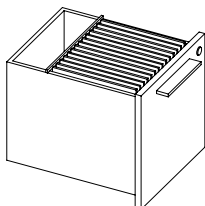

FILE RAILS ACCOMMODATE LEGAL SIDE TO SIDE; FILE BAR CAN BE USED TO ACCOMMODATE LETTER SIDE TO SIDE

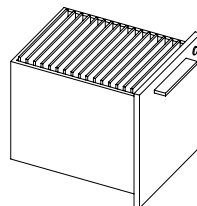

FRONT TO BACK ACCOMMODATES LETTER ONLY

*Loads are expressed as weight rating for filing, not bottom loading

Counterweights

Product Safety

All of BRC's storage products that contain box drawers and file drawers include full extension drawer slides. This presents a unique challenge as the further a drawer is extended, the further away the center of gravity is from the main body of the product. Depending on the load, the storage product may tip over. There are several ways to prevent this from happening and BRC recommends the following solutions be considered depending on the installation. For more information on your specific layout, contact your BRC representative for advice.

Counterweights

Counterweights are designed to help balance a load in a drawer or several drawers. Depending on the size of the storage product and the load it intends to carry, a counterweight may be the best option. For smaller cabinets, freestanding or mobile, BRC recommends using a counterweight to prevent the product from tipping over. Some of BRC's mobile storage options already include a 5th wheel caster in the front of the drawer which prevents tip over. In this case, the counterweight will not be listed as an option on the individual product page.

Counterweight located
in back of cabinet (shown)
or underneath cabinet

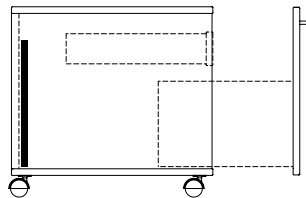

Ganging

When cabinets are installed in a long run or back to back, ganging them together may be the most cost effective solution. When installing, the drawers can be removed to gain access to the inside back or side gable of the product. After leveling the cabinet layout, by simply using self tapping wood screws with or without pilot holes, items can be ganged together.

Ganging cabinets back to back
or side to side provides a cost
effective solution

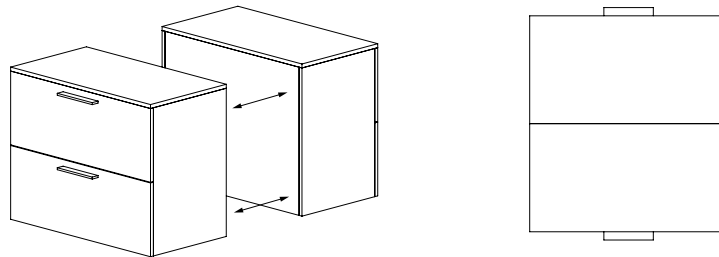

Wall Mounting

Where applicable, wall mounting can provide a cost effective solution to using a counterweight and provide greater tip over protection. For taller cabinets, bookcases and lockers BRC recommends wall mounting to provide a secure and safe environment. Ensure the wall structure contains wood studs or a wood backing. Attaching to metal studs alone is not recommended. Remove the drawers to gain access to the inside back or side gable of the product. After leveling the cabinet, simply use self tapping wood screws with or without pilot holes and secure the cabinet to the wall. Replace the drawers to complete installation.

Wall mounting all tall storage
cabinets, bookcases and lockers
is recommended

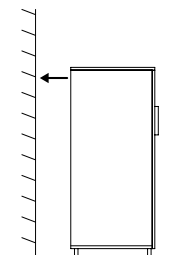

Wall Mounted Products

Wall mounted items require special consideration before installation. Any product attached to the wall, especially overhead mounted items, must be anchored and secured to the wall to ensure safety and stability. BRC provides the following guidelines & warnings when using wall mounted products:

- This product must be anchored to wall to ensure stability & safety.
- It is the owner and installers responsibility to ensure that the wall type and construction is of sufficient strength to carry the loads of any wall mounted products and their contents.
- Failure of the wall and anchors to support all imposed loads may result in property damage or personal injury.
- BRC can provide size and empty weight of its products only. As wall blocking is considered a building construction process, BRC cannot provide recommendations in this respect and cannot be responsible for damage or injury that may occur as a result of improper installation and/or blocking.

Look for this warning label on all wall mounted BRC products

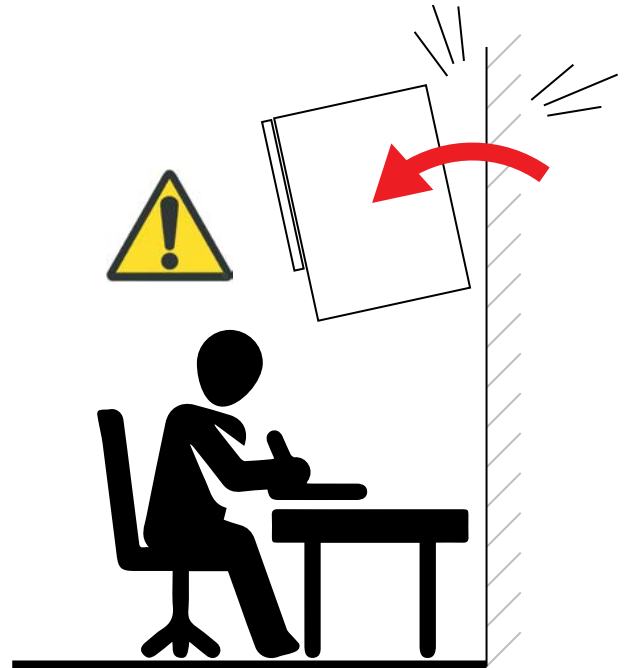

Mobile Product Instability

Mobile items on casters such as flip top, personal and movable tables of any type and storage items of any type may present an instability hazard if not secured correctly while in use or in storage. Flip top tables or training tables of any type, are inherently more unstable when folded. BRC provides the following guidelines & warnings when using mobile products:

- Lock casters immediately after moving. Do not leave the casters unlocked when in use or in storage.
- Motion may increase the instability of any item with casters. If the wheels hit an obstruction the table's forward momentum often causes overturn, especially if the item is not equipped with wheel extensions. Exercise strong caution while moving these items.
- Use caution when abrupt level changes in the floor are present (such as a doorway or room threshold) as caster failure or tipping may result.
- Do not stand, sit or lean on mobile items for support. They are not intended for this use and personal injury or property damage may result.
- Mobile units that feature height adjustable elements must be lowered to the minimum compressed height when moving to prevent instability. It is also recommended the user remove all computer equipment or other accessories to prevent possible weight imbalance or damage to equipment.
- Failure to follow the guidelines above may result in property damage or personal injury.

Look for this warning label on all mobile BRC products

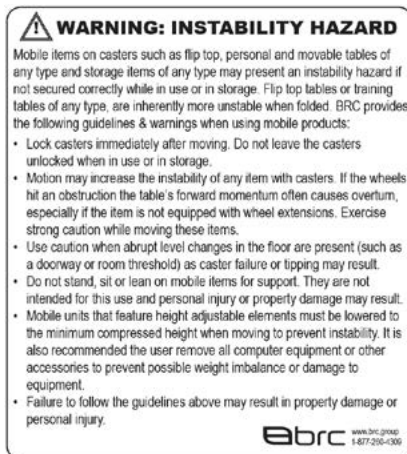

Cleaning & Maintenance

BEST PRACTICES

To keep your furniture products looking their best, BRC recommends the following general care and maintenance:

Low Pressure (LPL) LAMINATES Cleaning:

Dust laminated surfaces off prior to cleaning. Wet a damp cloth with water, a mild soap or one of our approved cleaning products. Do not use abrasive cleaners as they may scratch or affect the surface appearance. Wipe the surface with the grain (where applicable) using a dry soft cloth.

Approved cleaning products: Glass Plus®, Dawn®, Pledge®, Mr. Clean®, Windex®,

For disinfecting surfaces use products such as: LYSOL®, VIREX®, PURELL®, VIROX®

After use of the above disinfectants ensure that the surfaces are wiped with a damp cloth to remove any product residue.

Take note that any product with Hydrochloric, Sulfuric, or Phosphoric acid may permanently damage the surface. Abrasive elements and excessively acidic or alkaline solutions should be avoided. Prolonged exposure to wet surfaces and/or direct contact with water should be avoided.

High Pressure (HPL) LAMINATES Cleaning:

Dust laminated surfaces off prior to cleaning. Wet a damp cloth with water, a mild soap or one of our approved cleaning products. Do not use abrasive cleaners as they may scratch or affect the surface appearance. Wipe the surface with the grain (where applicable) using a dry soft cloth.

Approved cleaning products: Glass Plus®, Dawn®, Pledge®, Mr. Clean®, Windex®,

For disinfecting surfaces use products such as: LYSOL®, VIREX®, PURELL®, VIROX®, Fantastik®, multi-surface disinfectant, Clorox® Disinfecting Wipes, Caviwipes™, Cavicide™

After use of the above disinfectants ensure that the surfaces are wiped with a damp cloth to remove any product residue.



Do not saturate or soak furniture with cleaner



Use spray or damp cloth only



Wipe with damp cloth using fresh water after cleaning

Take note that any product with Hydrochloric, Sulfuric, or Phosphoric acid may permanently damage the surface. Abrasive elements and excessively acidic or alkaline solutions should be avoided. Prolonged exposure to wet surfaces and/or direct contact with water should be avoided.

Acrylic Tiles And Panels:

Dust regularly to keep surfaces free of dust particles. Clean any dirt or stain with a damp cloth. Do not use chemical cleaners or window cleaners as it may alter or permanently affect the surface appearance.

Tempered & Laminated Glass:

Dust regularly to keep surfaces free of dust particles. Clean any dirt or stain with a damp cloth. Do not use chemical cleaners or window cleaners as it may alter or permanently affect the surface appearance.

Edge Trim:

To remove minor scuff marks and general dirt from bases and connectors, use warm water and a soft cloth. Do not use harsh abrasive cleaners, as they may cause permanent scratches on the surface.

Painted Metals:

Clean these products, use a damp cloth, using only a small amount of lukewarm water if necessary. Abrasive elements and excessively acidic or alkaline solutions should be avoided. Prolonged exposure to wet surfaces and/or direct contact with water should be avoided.

Standard Fabrics:

Standard Care Label W-S. Clean with water based cleaning agents, foam or pure, water free solvents. Vacuuming or light brushing is recommended to prevent dust and soil buildup.

Bleach Cleanable Fabrics:

Bleach is an effective disinfectant, which means it kills most bacteria, fungi and viruses. When fabrics need to be disinfected or sterilized, use a 1:10 household bleach-to-water solution.

Standard & Custom Sizing

BRC has built a reputation on custom tailored product based on our standard offering. Many sizes not listed in the Emotion catalog can still be ordered without requesting a custom quote. The next two pages are meant as a guide to enable users to specify and order a custom size right from the price guide. Follow the guidelines below for specifying and ordering sizes that are not listed in this guide.

Worksurface Size & Pinch Clearance

Standard worksurface sizes listed in the size chart on each page are actual sizes. For instance, a 60" x 24" height adjustable table is manufactured to 60.00" x 24.00". This applies to all products in this guide - Mesa, Viva, SoHo and NoLita.

All Mesa and Viva height adjustable tables are sized to allow for one inch of pinch clearance at the back and on each side of the table. This allows for wire access behind and to the side of the table and provides clearance to avoid pinch points.

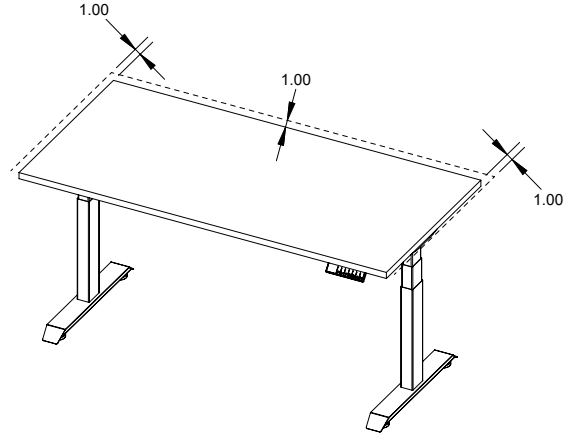
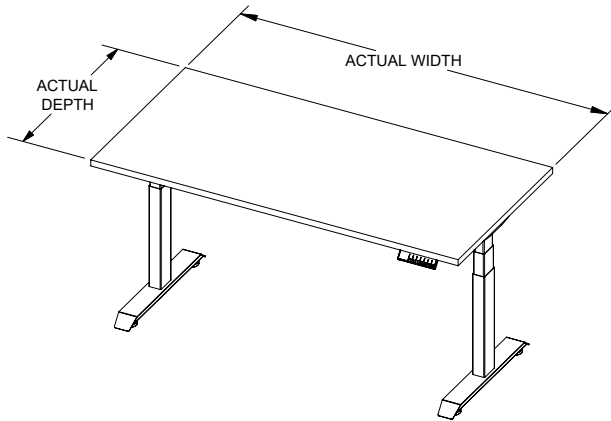

Custom Size Availability

Most products can be ordered in 0.25" (1/4") increments in either width or depth depending on the sizes listed in the price guide. Custom increments are available between the minimum and maximum sizes listed on the price page. For instance, in the example below, a Mesa table that has a minimum width of 46" and a maximum width of 82" is available in any size in between the minimum and maximum, for example, 54.25" wide or 70.75" wide. When specifying custom, indicate the actual size required, no additions or deductions will be made by BRC. For example, a custom specified width of 65" will be made at 65.00" exactly.

The example details width only but custom size availability applies to depth as well. If applicable, all variables (width, depth & height) can be customized together in one product. For example, the below item could be ordered with a custom width and depth.

Custom sizes outside of the listed minimum and maximum may still be available but require a quote from BRC. Please contact your representative or send your inquiry to quotes@brc.group.

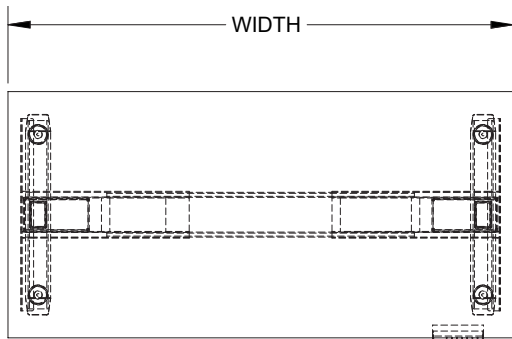

Next Size Up Pricing

When specifying a custom size, use the pricing applicable to the next size up listed in the price guide. For instance, for a 50.5" width overall, the next largest standard width is 54" at \$400 list, so for a 50.5" depth you would use the \$400 list price.

For more information on next size up pricing, please contact your representative or send your inquiry to quotes@brc.group.

PRODUCT MAP
TABLE OF CONTENTS
MESA ELECTRIC
VIVA ELECTRIC
VIVA MANUAL
VIVA INCREMENTAL
VIVA FIXED HEIGHT
SOHO
NOLITA
CONTROLLERS
www.brc.group

Custom Sizing

Order Sample Code

Ordering custom sizes is as easy as placing the size you want in the ordering code and adding an "SP-" prefix to the code. The example below shows how a height adjustable table can be customized and ordered. MWEE Viva product is available in widths from 26" - 82" and depths from 23" - 35". In the order code for a custom size, "MWEE" becomes "SP-MWEE".

Viva 2 Leg Electric Table

MWEE

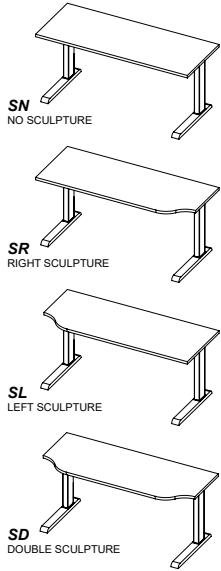

ACTUAL SIZE			LAMINATE	
WIDTH	DEPTH	WEIGHT/CUBE	PRICE M1	PRICE H1
82"	35"	120/72	2,987	3,021
82"	29"	120/72	2,646	2,680
76"	29"	110/72	2,521	2,561
70"	29"	110/72	2,384	2,425
64"	29"	110/60	2,384	2,425
58"	29"	110/60	2,344	2,344
46"	29"	105/48	2,248	2,248
40"	29"	95/48	2,140	2,140
34"	29"	85/36	2,079	2,113
28"	29"	70/30	2,045	2,084
94"	23"	120/72	2,987	3,021
82"	23"	120/72	2,533	2,567
76"	23"	115/72	2,407	2,447
70"	23"	115/72	2,271	2,311
64"	23"	105/60	2,181	2,231
58"	23"	100/48	2,101	2,135
46"	23"	90/48	1,988	2,027
40"	23"	80/36	1,965	1,998
34"	23"	70/30	1,930	1,970
28"	23"	70/30	1,920	1,959

NOTE:
THIS PAGE USES PRODUCT MWEE AS AN EXAMPLE ONLY. OTHER PRODUCTS WILL HAVE DIFFERENT SIZE VARIATIONS DEPENDING ON THE MINIMUM AND MAXIMUM SIZES LISTED. CONSULT EACH PRODUCT PAGE FOR DETAILS ON ITS CUSTOM SIZE AVAILABILITY.

ORDER CODE SAMPLE					
ITEM CODE	WIDTH	DEPTH	LAMINATE	SCULPTURE	OPTION
MWEE	70	23	H1	SN	LMP

Features & Specifications

- Leg provides 1" of leveling
- Laminate codes - M1; 1" LPL, H1: 1" HPL (top only)
- Specify sculpture - 'SN' - none, 'SR' - right, 'SL' - left, or 'SD' - double
- Woodgrain runs horizontally if applicable
- Sculpture is 6" deep (eg: 23" depth is 17" at edge when sculptured)

No Charge Options

- Available in all standard laminates
- Available in standard metal paint finishes
- For sizes not listed, specify actual (not nominal) size in product code

Optional Extra

- Specify GL (left), GC (center) and/or GR (right) for grommet; add \$56 per grommet
- Specify LMP for laminate modesty panel; add \$126 for tables 48" wide or less and \$205 for tables over 48" wide
- 6" Bow fronts for tables 58" and larger available; add BF to code and \$158

PRODUCT MAP
TABLE OF CONTENTS
MESA ELECTRIC
VIVA ELECTRIC
VIVA MANUAL
VIVA INCREMENTAL
VIVA FIXED HEIGHT
SOHO
NOLITA
CONTROLLERS
www.brc.group

DEPTHS AVAILABLE FROM 23" TO 35" ONLY
WIDTHS AVAILABLE FROM 26" TO 82" ONLY

ORDER CODE SAMPLE FOR STANDARD SIZES

ORDER CODE SAMPLE FOR CUSTOM SIZES

ORDER CODE SAMPLE - CUSTOM SIZE				
ITEM CODE	WIDTH	DEPTH	LAMINATE	SCULPTURE
SP-MWEE	69	26	M1	SN

NEXT SIZE UP SIZE:
MWEE 70 29 M1

NEXT SIZE UP PRICE:
\$ 2,384

ADD "SP-" BEFORE STANDARD CODE

AVAILABLE IN WIDTHS FROM 26" TO 82"

AVAILABLE IN DEPTHS FROM 23" TO 35"

PRODUCT MAP
TABLE OF CONTENTS
MESA ELECTRIC
VIVA ELECTRIC
VIVA MANUAL
VIVA INCREMENTAL
VIVA FIXED HEIGHT
SOHO
NOLITA
CONTROLLERS
www.brc.group

Product Map

Mesa Electric T Base SPEC PAGE

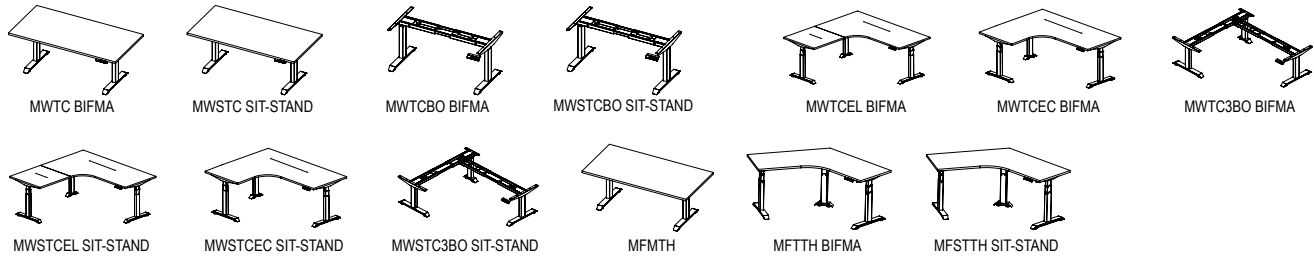

Mesa Electric C Base

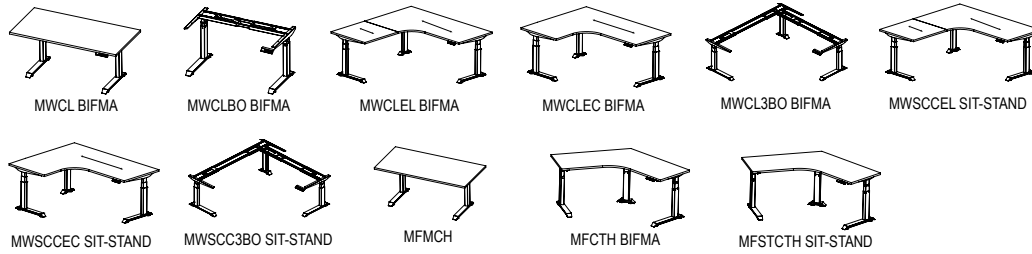

Mesa Electric Wall Mount

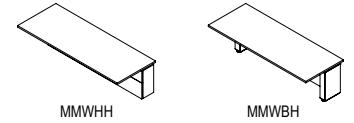

Mesa Leg Surround APPLICATION

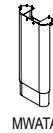

Viva Electric SPEC PAGE

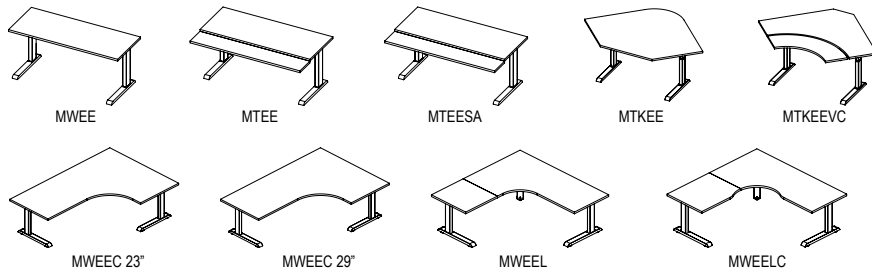

Viva Manual SPEC PAGE

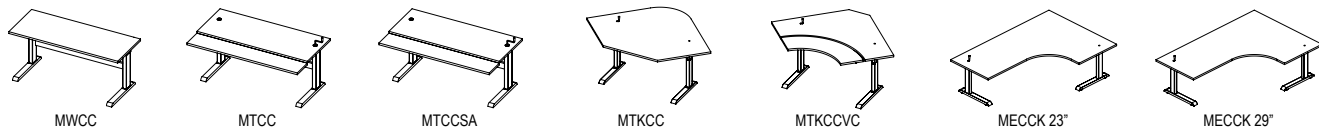

Viva Incremental SPEC PAGE

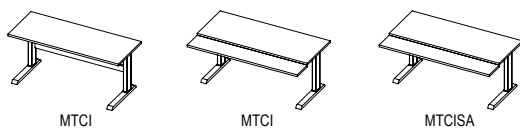

Viva Fixed Height SPEC PAGE

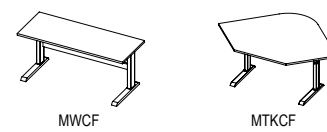

SoHo SPEC PAGE

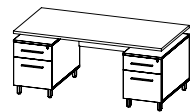

NoLita SPEC PAGE

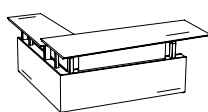

Controller Options



VIVA

Rechargeable Battery

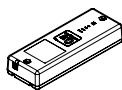

VIVA

Casters



MESA



VIVA

HA Table Support SPEC PAGE

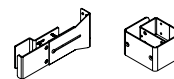

Mesa

Economical Electric Height Adjustable Tables

Standard Features:

- LPL & HPL Worksurfaces available with overall height adjustability from 22.75" to 48.75"
- Programmable anti collision enabled - table will stop if obstruction is encountered
- Full undersurface adjustable width frame prevents lateral movement
- Power ratings: 456W, 3.8 Amp working, 0.5W standby, 108" power cord
- Includes cable management ties for under surface attachment
- Four position memory handset with digital height display
- Modesty free design meets ADA accessibility requirements
- Dual motor with a lift capacity up to 275lbs.
- Optional modesty panel is 10" high

Basic Dimensions:

T-LEG, C-LEG

- Column: 1.9" x 3.0" [48mm x 76mm]
- Foot: 2.95" x 23.65" [75mm x 601mm]
- Foot height: 1.59" [40mm]

FRAME

- 1.25" horizontal top frame

Finishes:

BASE

- Powdercoat silver, black & white

WORKSURFACE

- 1" LPL & HPL in all standard BRC laminates

General Product Overview:

Table bases are metal and have a durable scratch resistant, heat cured powder coat paint finish. Metal uprights are 14 gauge tubing and incorporate plastic sleeves throughout for quiet and smooth operation. Low profile foot is constructed of heavy gauge welded steel, with waterfall front and back edges. Feet have oversize levelers for greater stability.

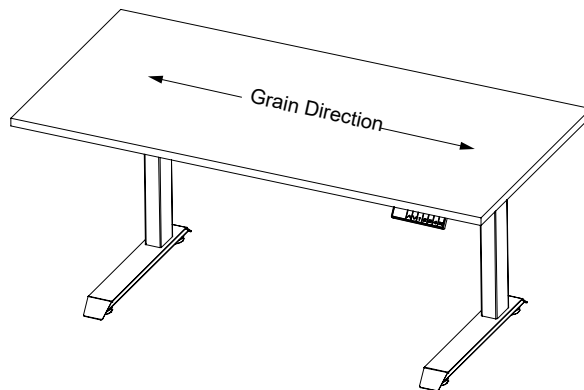
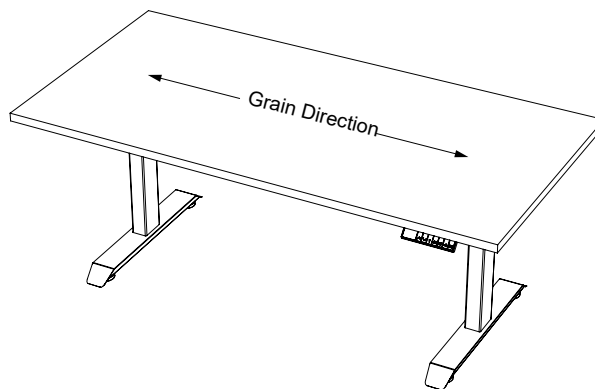

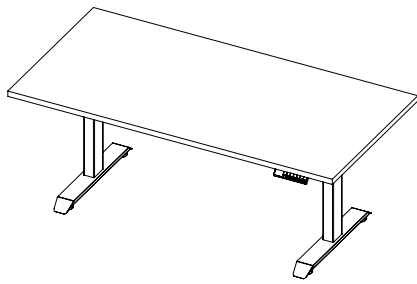

ACTUAL SIZE			LAMINATE	
WIDTH	DEPTH	WEIGHT	PRICE M1	PRICE H1
46"	23"	97	\$2,035	\$2,107
58"	23"	102	\$2,167	\$2,310
70"	23"	107	\$2,167	\$2,310
76"	23"	110	\$2,167	\$2,310
82"	23"	113	\$2,167	\$2,310
46"	29"	102	\$2,167	\$2,310
58"	29"	109	\$2,431	\$2,718
70"	29"	116	\$2,431	\$2,718
76"	29"	119	\$2,431	\$2,718
82"	29"	123	\$2,431	\$2,718
82"	35"	132	\$2,431	\$2,718



ORDER CODE SAMPLE				
ITEM CODE	WIDTH	DEPTH	LAMINATE	OPTION
MWTC	70	23	H1	LMP

Features & Specifications

- Leg provides 1" of leveling
- Laminate codes - M1: 1" LPL, H1: 1" HPL (top only)
- Woodgrain runs width wise if applicable
- The BIFMA height range is 22.75" to 48.75" including the 1" top

No Charge Options

- Available in all standard laminates
- Available in standard metal paint finishes
- For sizes not listed, specify actual (not nominal) size in product code

Optional Extra

- For 3" grommet (AG30A), add option code(s) 'GL', 'GC' and/or 'GR', add +\$86 per grommet
- For laminate modesty panel, add option code 'LMP' and +\$313

Mesa Rectangular 2 Leg Electric T Base Table Sit-Stand

MWSTC

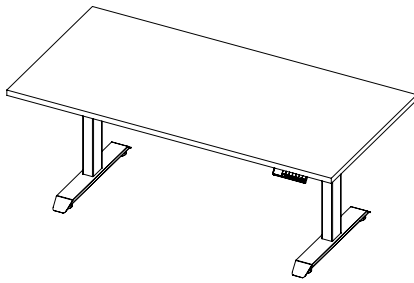

ACTUAL SIZE			LAMINATE	
WIDTH	DEPTH	WEIGHT	PRICE M1	PRICE H1
46"	23"	97	\$2,035	\$2,107
58"	23"	102	\$2,167	\$2,310
70"	23"	107	\$2,167	\$2,310
76"	23"	110	\$2,167	\$2,310
82"	23"	113	\$2,167	\$2,310
46"	29"	102	\$2,167	\$2,310
58"	29"	109	\$2,431	\$2,718
70"	29"	116	\$2,431	\$2,718
76"	29"	119	\$2,431	\$2,718
82"	29"	123	\$2,431	\$2,718
82"	35"	132	\$2,431	\$2,718



ORDER CODE SAMPLE				
ITEM CODE	WIDTH	DEPTH	LAMINATE	OPTION
MWSTC	70	23	H1	LMP

Features & Specifications

- Leg provides 1" of leveling
- Laminate codes - M1: 1" LPL, H1: 1" HPL (top only)
- Woodgrain runs width wise if applicable
- The Sit to Stand height range is 25" to 51" including the 1" top

No Charge Options

- Available in all standard laminates
- Available in standard metal paint finishes
- For sizes not listed, specify actual (not nominal) size in product code

Optional Extra

- For 3" grommet (AG30A), add option code(s) 'GL', 'GC' and/or 'GR', add +\$86 per grommet
- For laminate modesty panel, add option code 'LMP' and +\$313

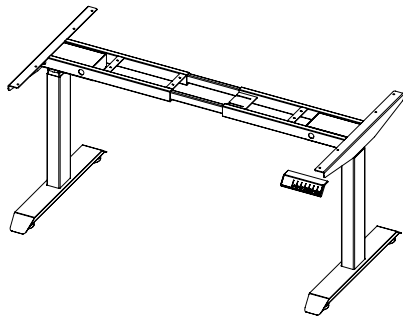

MWTCBO	
FEATURES & SPECIFICATIONS	PRICE
<ul style="list-style-type: none"> • Frame extends to 71" wide • Accommodates worksurface sizes of 40" - 84" wide by 24" - 30" deep 	\$1,663

Features & Specifications

No Charge Options



ORDER CODE SAMPLE
ITEM CODE
MWTCBO

- Leg provides 1" of leveling
 - All kits include base frame, feet, levellers and Mesa handset controller
 - Assembly instructions included in box
 - Worksurface fastening hardware not included. Screws should be chosen by the installer taking into account the thickness of worksurface used
 - The BIFMA height range is 22.75" to 48.75" including the 1" top
-
- Available in standard metal paint finishes



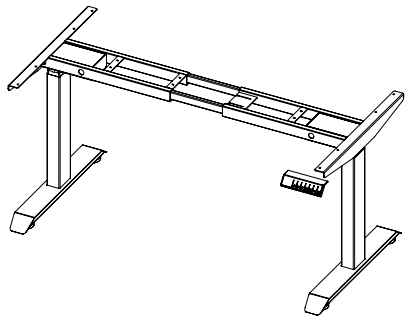

MWSTCBO	
FEATURES & SPECIFICATIONS	PRICE
<ul style="list-style-type: none"> • Frame extends to 71" wide • Accommodates worksurface sizes of 40" - 84" wide by 24" - 30" deep 	\$1,663

Features & Specifications

No Charge Options



ORDER CODE SAMPLE
ITEM CODE
MWSTCBO

- Leg provides 1" of leveling
 - All kits include base frame, feet, levellers and Mesa handset controller
 - Assembly instructions included in box
 - Worksurface fastening hardware not included. Screws should be chosen by the installer taking into account the thickness of worksurface used
 - The Sit to Stand height range is 25" to 51" including the 1" top
-
- Available in standard metal paint finishes

Mesa T Leg Foot with Caster

AQMFM

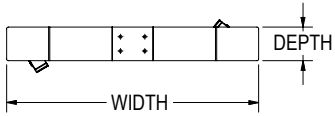
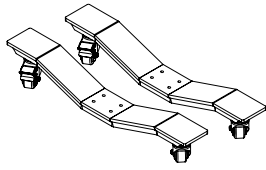

ACTUAL SIZE

WIDTH	DEPTH	PRICE
23.75	3.25	\$281

Features & Specifications

No Charge Options



ORDER CODE SAMPLE
ITEM CODE
AQMFM

- Kit includes one pair of feet with casters
- Includes twin wheel casters
- Used for two leg T configurations only
- Adjusted height range with BIFMA column: 23" to 48.25"

- Available in standard metal paint finishes

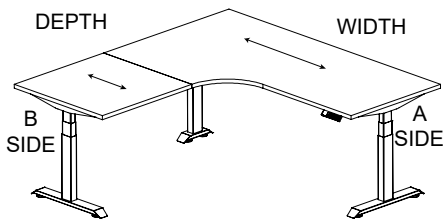

MR
MAIN RIGHT EXTENDED

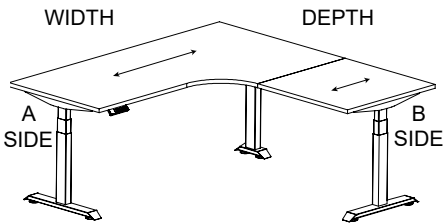

ML
MAIN LEFT EXTENDED

ARROWS INDICATE GRAIN DIRECTION
(IF APPLICABLE)

ACTUAL SIZE					LAMINATE	
WIDTH	DEPTH	A SIDE	B SIDE	RADIUS	PRICE M1	PRICE H1
64"	64"	23" or 29"	23" or 29"	18"	\$4,152	\$4,766
64"	70"	23" or 29"	23" or 29"	18"	\$4,152	\$4,766
64"	76"	23" or 29"	23" or 29"	18"	\$4,152	\$4,766
64"	82"	23" or 29"	23" or 29"	18"	\$4,152	\$4,766
70"	64"	23" or 29"	23" or 29"	18"	\$4,152	\$4,766
70"	70"	23" or 29"	23" or 29"	18"	\$4,152	\$4,766
70"	76"	23" or 29"	23" or 29"	18"	\$4,152	\$4,766
70"	82"	23" or 29"	23" or 29"	18"	\$4,152	\$4,766
76"	64"	23" or 29"	23" or 29"	18"	\$4,152	\$4,766
76"	70"	23" or 29"	23" or 29"	18"	\$4,152	\$4,766
76"	76"	23" or 29"	23" or 29"	18"	\$4,152	\$4,766
76"	82"	23" or 29"	23" or 29"	18"	\$4,152	\$4,766
82"	64"	23" or 29"	23" or 29"	18"	\$4,152	\$4,766
82"	70"	23" or 29"	23" or 29"	18"	\$4,152	\$4,766
82"	76"	23" or 29"	23" or 29"	18"	\$4,152	\$4,766
82"	82"	23" or 29"	23" or 29"	18"	\$4,152	\$4,766



ORDER CODE SAMPLE							
ITEM CODE	A SIDE	WIDTH	DEPTH	B SIDE	LAMINATE	HAND	OPTION
MWTCEL	23	82	76	23	M1	ML	LMP

Features & Specifications

No Charge Options

Optional Extra

- Leg provides 1" of leveling
- Laminate codes - M1: 1" LPL, H1: 1" HPL (top only)
- Woodgrain runs width wise if applicable
- Specify hand - "MR" main right extended, "ML" main left extended
- The BIFMA height range is 22.75" to 48.75" including the 1" top
- Available in all standard laminates
- Available in standard metal paint finishes
- For sizes not listed, specify actual (not nominal) size in product code
- For strait front instead of curved front add "SF" to option code
- For 3" grommet (AG30A), add option code(s) 'GL', 'GC' and/or 'GR', add +\$86 per grommet
- For laminate modesty panel, add option code 'LMP' and +\$386

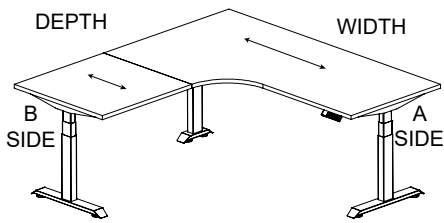

MR
MAIN RIGHT EXTENDED

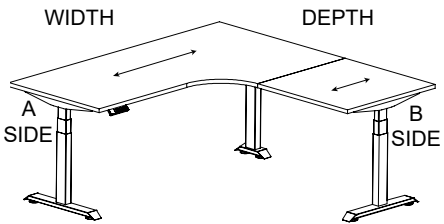

ML
MAIN LEFT EXTENDED

ARROWS INDICATE GRAIN DIRECTION
(IF APPLICABLE)

ACTUAL SIZE					LAMINATE	
WIDTH	DEPTH	A SIDE	B SIDE	RADIUS	PRICE M1	PRICE H1
64"	64"	23" or 29"	23" or 29"	18"	\$4,152	\$4,766
64"	70"	23" or 29"	23" or 29"	18"	\$4,152	\$4,766
64"	76"	23" or 29"	23" or 29"	18"	\$4,152	\$4,766
64"	82"	23" or 29"	23" or 29"	18"	\$4,152	\$4,766
70"	64"	23" or 29"	23" or 29"	18"	\$4,152	\$4,766
70"	70"	23" or 29"	23" or 29"	18"	\$4,152	\$4,766
70"	76"	23" or 29"	23" or 29"	18"	\$4,152	\$4,766
70"	82"	23" or 29"	23" or 29"	18"	\$4,152	\$4,766
76"	64"	23" or 29"	23" or 29"	18"	\$4,152	\$4,766
76"	70"	23" or 29"	23" or 29"	18"	\$4,152	\$4,766
76"	76"	23" or 29"	23" or 29"	18"	\$4,152	\$4,766
76"	82"	23" or 29"	23" or 29"	18"	\$4,152	\$4,766
82"	64"	23" or 29"	23" or 29"	18"	\$4,152	\$4,766
82"	70"	23" or 29"	23" or 29"	18"	\$4,152	\$4,766
82"	76"	23" or 29"	23" or 29"	18"	\$4,152	\$4,766
82"	82"	23" or 29"	23" or 29"	18"	\$4,152	\$4,766



ORDER CODE SAMPLE							
ITEM CODE	A SIDE	WIDTH	DEPTH	B SIDE	LAMINATE	HAND	OPTION
MWSTCEL	23	82	76	23	M1	ML	LMP

Features & Specifications

No Charge Options

Optional Extra

- Leg provides 1" of leveling
- Laminate codes - M1: 1" LPL, H1: 1" HPL (top only)
- Woodgrain runs width wise if applicable
- Specify hand - "MR" main right extended, "ML" main left extended
- The height range is 25" to 51" including the 1" top
- Available in all standard laminates
- Available in standard metal paint finishes
- For sizes not listed, specify actual (not nominal) size in product code
- For strait front instead of curved front add "SF" to option code
- For 3" grommet (AG30A), add option code(s) 'GL', 'GC' and/or 'GR', add +\$86 per grommet
- For laminate modesty panel, add option code 'LMP' and +\$386

PRODUCT MAP

TABLE OF CONTENTS

MESA ELECTRIC

VIVA ELECTRIC

VIVA MANUAL

VIVA INCREMENTAL

VIVA FIXED HEIGHT

SOHO

NOLITA

CONTROLLERS

www.brc.group

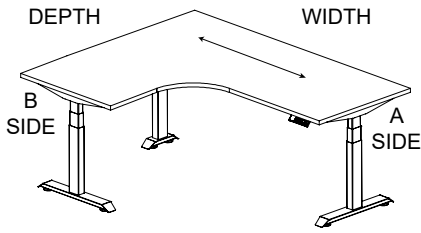

MR
MAIN RIGHT EXTENDED

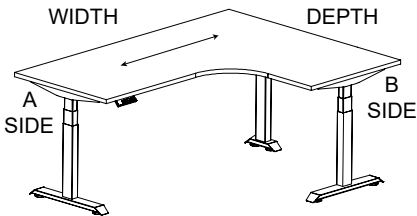

ML
MAIN LEFT EXTENDED

ARROWS INDICATE GRAIN DIRECTION
(IF APPLICABLE)

ACTUAL SIZE					LAMINATE	
WIDTH	DEPTH	A SIDE	B SIDE	RADIUS	PRICE M1	PRICE H1
58"	40"	23"	23" or 29"	12"	\$3,887	\$4,255
64"	40"	23"	23" or 29"	12"	\$3,887	\$4,255
70"	40"	23"	23" or 29"	12"	\$3,887	\$4,255
76"	40"	23"	23" or 29"	12"	\$3,887	\$4,255
82"	40"	23"	23" or 29"	12"	\$3,887	\$4,255
58"	46"	23"	23" or 29"	18"	\$3,902	\$4,272
64"	46"	23"	23" or 29"	18"	\$3,902	\$4,272
70"	46"	23"	23" or 29"	18"	\$3,902	\$4,272
76"	46"	23"	23" or 29"	18"	\$3,902	\$4,272
82"	46"	23"	23" or 29"	18"	\$3,902	\$4,272
58"	52"	23" or 29"	23" or 29"	18"	\$3,918	\$4,285
64"	52"	23" or 29"	23" or 29"	18"	\$3,918	\$4,285
70"	52"	23" or 29"	23" or 29"	18"	\$3,918	\$4,285
76"	52"	23" or 29"	23" or 29"	18"	\$3,918	\$4,285
82"	52"	23" or 29"	23" or 29"	18"	\$3,918	\$4,285
64"	58"	23" or 29"	23" or 29"	18"	\$3,933	\$4,300
70"	58"	23" or 29"	23" or 29"	18"	\$3,933	\$4,300
76"	58"	23" or 29"	23" or 29"	18"	\$3,933	\$4,300
82"	58"	23" or 29"	23" or 29"	18"	\$3,933	\$4,300



ORDER CODE SAMPLE						
ITEM CODE	EWIDTH	DEPTH	B SIDE	LAMINATE	HAND	OPTION
MWTCEC	82	52	29	M1	ML	LMP

Features & Specifications

No Charge Options

Optional Extra

- Leg provides 1" of leveling
- Laminate codes - M1: 1" LPL, H1: 1" HPL (top only)
- Woodgrain runs width wise if applicable
- Specify hand - "MR" main right extended, "ML" main left extended
- The BIFMA height range is 22.75" to 48.75" including the 1" top
- Available in all standard laminates
- Available in standard metal paint finishes
- For sizes not listed, specify actual (not nominal) size in product code
- For strait front instead of curved front add "SF" to option code
- For 3" grommet (AG30A), add option code(s) 'GL', 'GC' and/or 'GR', add +\$86 per grommet
- For laminate modesty panel, add option code 'LMP' and +\$386

PRODUCT MAP

TABLE OF CONTENTS

MESA ELECTRIC

VIVA ELECTRIC

VIVA MANUAL

VIVA INCREMENTAL

VIVA FIXED HEIGHT

SOHO

NOLITA

CONTROLLERS

www.brc.group

Mesa 1pc Top 3 Leg Electric T Base Table Sit-Stand

MWSTCEC

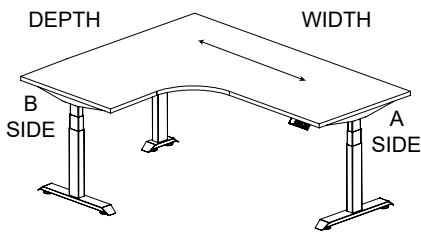

MR
MAIN RIGHT EXTENDED

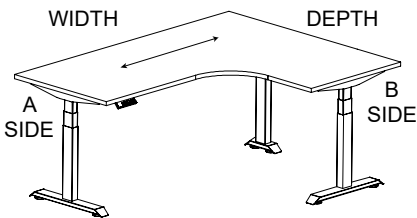

ML
MAIN LEFT EXTENDED

ARROWS INDICATE GRAIN DIRECTION
(IF APPLICABLE)

ACTUAL SIZE					LAMINATE	
WIDTH	DEPTH	A SIDE	B SIDE	RADIUS	PRICE M1	PRICE H1
58"	40"	23"	23" or 29"	12"	\$3,887	\$4,255
64"	40"	23"	23" or 29"	12"	\$3,887	\$4,255
70"	40"	23"	23" or 29"	12"	\$3,887	\$4,255
76"	40"	23"	23" or 29"	12"	\$3,887	\$4,255
82"	40"	23"	23" or 29"	12"	\$3,887	\$4,255
58"	46"	23"	23" or 29"	18"	\$3,979	\$4,272
64"	46"	23"	23" or 29"	18"	\$3,979	\$4,272
70"	46"	23"	23" or 29"	18"	\$3,979	\$4,272
76"	46"	23"	23" or 29"	18"	\$3,979	\$4,272
82"	46"	23"	23" or 29"	18"	\$3,979	\$4,272
58"	52"	23" or 29"	23" or 29"	18"	\$3,993	\$4,285
64"	52"	23" or 29"	23" or 29"	18"	\$3,993	\$4,285
70"	52"	23" or 29"	23" or 29"	18"	\$3,993	\$4,285
76"	52"	23" or 29"	23" or 29"	18"	\$3,993	\$4,285
82"	52"	23" or 29"	23" or 29"	18"	\$3,993	\$4,285
64"	58"	23" or 29"	23" or 29"	18"	\$4,009	\$4,300
70"	58"	23" or 29"	23" or 29"	18"	\$4,009	\$4,300
76"	58"	23" or 29"	23" or 29"	18"	\$4,009	\$4,300
82"	58"	23" or 29"	23" or 29"	18"	\$4,009	\$4,300



ORDER CODE SAMPLE							
ITEM CODE	A SIDE	WIDTH	DEPTH	B SIDE	LAMINATE	HAND	OPTION
MWSTCEC	29	82	52	29	M1	ML	LMP

Features & Specifications

No Charge Options

Optional Extra

- Leg provides 1" of leveling
- Laminate codes - M1: 1" LPL, H1: 1" HPL (top only)
- Woodgrain runs width wise if applicable
- Specify hand - "MR" main right extended, "ML" main left extended
- The height range is 25" to 51" including the 1" top
- Available in all standard laminates
- Available in standard metal paint finishes
- For sizes not listed, specify actual (not nominal) size in product code
- For strait front instead of curved front add "SF" to option code
- For 3" grommet (AG30A), add option code(s) 'GL', 'GC' and/or 'GR', add +\$86 per grommet
- For laminate modesty panel, add option code 'LMP' and +\$386



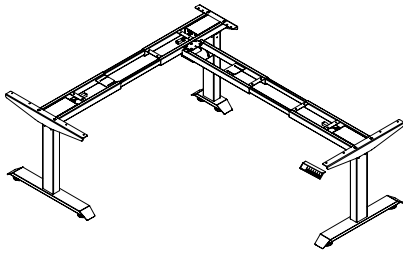

MWTC3BO	
FEATURES & SPECIFICATIONS	PRICE
<ul style="list-style-type: none"> Accommodates worksurface sizes of 48" - 84" wide, returns 48" to 84" wide 24" - 30" deep, and depths 24" - 30" 	\$2,915

Features & Specifications

No Charge Options



ORDER CODE SAMPLE
ITEM CODE
MWTC3BO

- Leg provides 1" of leveling
 - All kits include base frame, feet, levellers and Mesa handset controller
 - Assembly instructions included in box
 - Worksurface fastening hardware not included. Screws should be chosen by the installer taking into account the thickness of worksurface used
 - The BIFMA height range is 22.75" to 48.75" including the 1" top
-
- Available in standard metal paint finishes

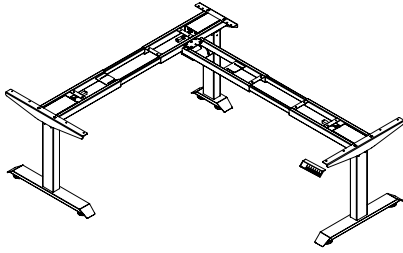

MWTC3BO	
FEATURES & SPECIFICATIONS	PRICE
<ul style="list-style-type: none"> Accommodates worksurface sizes of 48" - 84" wide, returns 48" to 84" wide 24" - 30" deep, and depths 24" - 30" 	\$2,915

Features & Specifications

No Charge Options



ORDER CODE SAMPLE
ITEM CODE
MWTC3BO

- Leg provides 1" of leveling
 - All kits include base frame, feet, levellers and Mesa handset controller
 - Assembly instructions included in box
 - Worksurface fastening hardware not included. Screws should be chosen by the installer taking into account the thickness of worksurface used
 - The height range is 25" to 51" including the 1" top
-
- Available in standard metal paint finishes

Mesa Rectangular 2 Leg Fixed T Base Table

MFMTH

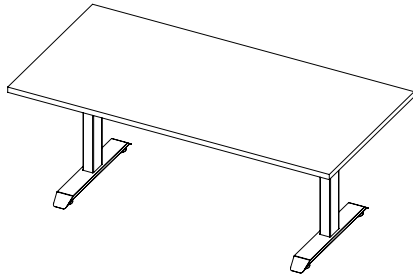

ACTUAL SIZE				LAMINATE	
WIDTH	DEPTH	HEIGHT	WEIGHT	PRICE M1	PRICE H1
24"	24"	29"	85	\$1,553	\$1,625
30"	24"	29"	88	\$1,553	\$1,625
36"	24"	29"	92	\$1,553	\$1,625
42"	24"	29"	95	\$1,553	\$1,625
48"	24"	29"	97	\$1,553	\$1,625
60"	24"	29"	102	\$1,684	\$1,827
72"	24"	29"	107	\$1,684	\$1,827
78"	24"	29"	110	\$1,684	\$1,827
84"	24"	29"	113	\$1,684	\$1,827
48"	30"	29"	102	\$1,684	\$1,827
60"	30"	29"	109	\$1,948	\$2,236
72"	30"	29"	116	\$1,948	\$2,236
78"	30"	29"	119	\$1,948	\$2,236
84"	30"	29"	123	\$1,948	\$2,236
84"	36"	29"	132	\$1,948	\$2,236



ORDER CODE SAMPLE					
ITEM CODE	WIDTH	DEPTH	HEIGHT	LAMINATE	OPTION
MFMTH	72	24	29	H1	LMP

Features & Specifications

- Leg provides 1" of leveling
- Laminate codes - M1: 1" LPL, H1: 1" HPL (top only)
- Woodgrain runs width wise if applicable

No Charge Options

- Available in all standard laminates
- Available in standard metal paint finishes
- For sizes not listed, specify actual (not nominal) size in product code

Optional Extra

- For 3" grommet (AG30A), add option code(s) 'GL', 'GC' and/or 'GR', add +\$86 per grommet
- For laminate modesty panel, add option code 'LMP' and +\$313

PRODUCT MAP
TABLE OF CONTENTS
MESA ELECTRIC
VIVA ELECTRIC
VIVA MANUAL
VIVA INCREMENTAL
VIVA FIXED HEIGHT
SOHO
NOLITA
CONTROLLERS
www.brc.group

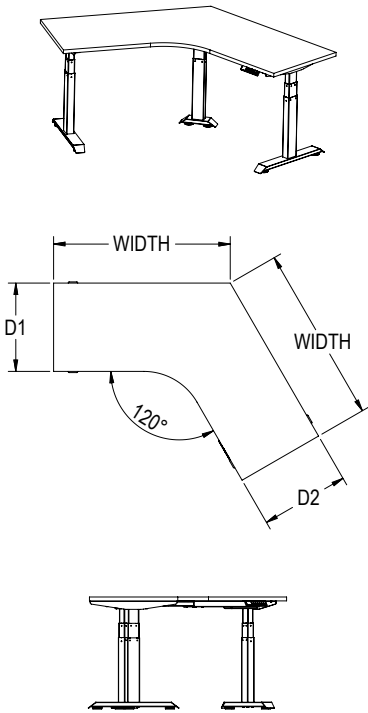

ACTUAL SIZE			LAMINATE	
WIDTH	A SIDE	B SIDE	PRICE M1	PRICE H1
34"	23" or 29"	23" or 29"	\$4,351	\$4,964
40"	23" or 29"	23" or 29"	\$4,351	\$4,964
46"	23" or 29"	23" or 29"	\$4,351	\$4,964
52"	23" or 29"	23" or 29"	\$4,351	\$4,964
58"	23" or 29"	23" or 29"	\$4,351	\$4,964

Features & Specifications

No Charge Options

Optional Extra



ORDER CODE SAMPLE					
ITEM CODE	A SIDE	WIDTH	B SIDE	LAMINATE	OPTION
MFSTTH	A23	W72	B29	H1	LMP

- Leg provides 1" of leveling
- Laminate codes - M1: 1" LPL, H1: 1" HPL (top only)
- Worksurface may have a seam
- The BIFMA height range is 22.75" to 48.75" including the 1" top

- Available in all standard laminates
- Available in standard metal paint finishes
- For sizes not listed, specify actual (not nominal) size in product code

- For 3" grommet (AG30A), add option code(s) 'GL', 'GC' and/or 'GR', add +\$86 per grommet
- For laminate modesty panel, add option code 'LMP' and +\$493

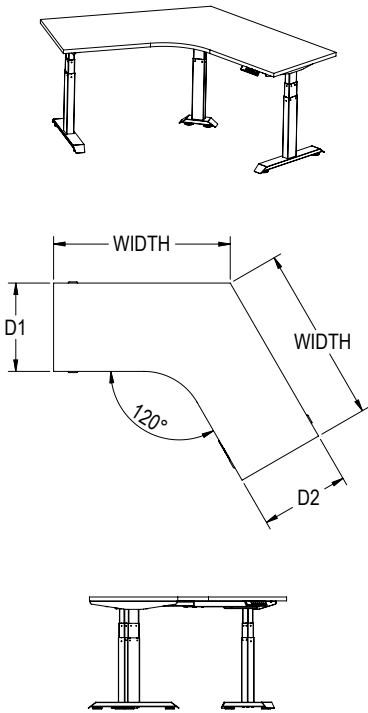

ACTUAL SIZE			LAMINATE	
WIDTH	A SIDE	B SIDE	PRICE M1	PRICE H1
34"	23" or 29"	23" or 29"	\$4,351	\$4,964
40"	23" or 29"	23" or 29"	\$4,351	\$4,964
46"	23" or 29"	23" or 29"	\$4,351	\$4,964
52"	23" or 29"	23" or 29"	\$4,351	\$4,964
58"	23" or 29"	23" or 29"	\$4,351	\$4,964

Features & Specifications

No Charge Options

Optional Extra



ORDER CODE SAMPLE					
ITEM CODE	A SIDE	WIDTH	B SIDE	LAMINATE	OPTION
MFSTTH	A23	W72	B29	H1	LMP

- Leg provides 1" of leveling
- Laminate codes - M1: 1" LPL, H1: 1" HPL (top only)
- Worksurface may have a seam
- The height range is 25" to 51" including the 1" top

- Available in all standard laminates
- Available in standard metal paint finishes
- For sizes not listed, specify actual (not nominal) size in product code

- For 3" grommet (AG30A), add option code(s) 'GL', 'GC' and/or 'GR', add +\$86 per grommet
- For laminate modesty panel, add option code 'LMP' and +\$493

Mesa Rectangular 2 Leg Electric C Base Table BIFMA

MWCL

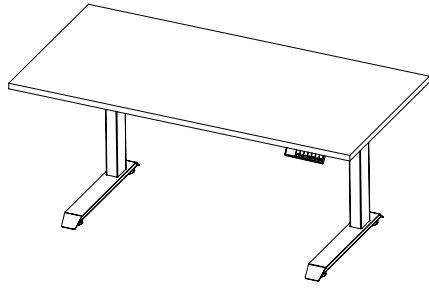

ACTUAL SIZE			LAMINATE	
WIDTH	DEPTH	WEIGHT	PRICE M1	PRICE H1
46"	23"	97	\$2,338	\$2,412
58"	23"	102	\$2,470	\$2,614
70"	23"	107	\$2,470	\$2,614
76"	23"	110	\$2,470	\$2,614
82"	23"	113	\$2,470	\$2,614
46"	29"	102	\$2,470	\$2,614
58"	29"	109	\$2,735	\$3,023
70"	29"	116	\$2,735	\$3,023
76"	29"	119	\$2,735	\$3,023
82"	29"	123	\$2,735	\$3,023
82"	35"	132	\$2,735	\$3,023



ORDER CODE SAMPLE				
ITEM CODE	WIDTH	DEPTH	LAMINATE	OPTION
MWCL	70	23	H1	LMP

Features & Specifications

- Leg provides 1" of leveling
- Laminate codes - M1: 1" LPL, H1: 1" HPL (top only)
- Woodgrain runs width wise if applicable
- The BIFMA height range is 22.75" to 48.75" including the 1" top

No Charge Options

- Available in all standard laminates
- Available in standard metal paint finishes
- For sizes not listed, specify actual (not nominal) size in product code

Optional Extra

- For 3" grommet (AG30A), add option code(s) 'GL', 'GC' and/or 'GR', add +\$86 per grommet
- For laminate modesty panel, add option code 'LMP' and +\$313



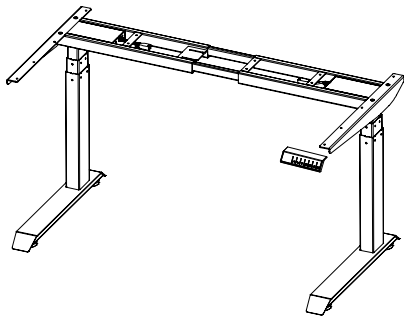

MWCLBO	
FEATURES & SPECIFICATIONS	PRICE
<ul style="list-style-type: none"> • Frame extends to 71" wide • Accommodates worksurface sizes of 40" - 84" wide by 24" - 30" deep 	\$1,971

Features & Specifications

No Charge Options



ORDER CODE SAMPLE
ITEM CODE
MWCLBO

- Leg provides 1" of leveling
 - All kits include base frame, feet, levellers and Mesa handset controller
 - Assembly instructions included in box
 - Worksurface fastening hardware not included. Screws should be chosen by the installer taking into account the thickness of worksurface used
 - The BIFMA height range is 22.75" to 48.75" including the 1" top
-
- Available in standard metal paint finishes

Mesa 2pc Top 3 Leg Electric C Base Table BIFMA

MWCLEL

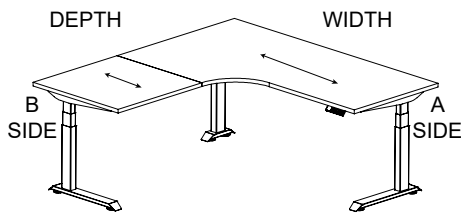

MR
MAIN RIGHT EXTENDED

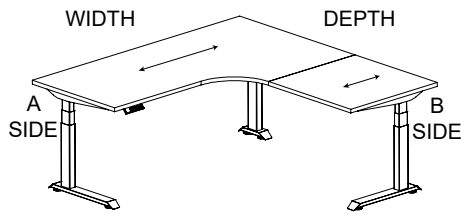

ML
MAIN LEFT EXTENDED

ARROWS INDICATE GRAIN DIRECTION
(IF APPLICABLE)

ACTUAL SIZE					LAMINATE	
WIDTH	DEPTH	A SIDE	B SIDE	RADIUS	PRICE M1	PRICE H1
64"	64"	23" or 29"	23" or 29"	18"	\$4,455	\$5,070
64"	70"	23" or 29"	23" or 29"	18"	\$4,455	\$5,070
64"	76"	23" or 29"	23" or 29"	18"	\$4,455	\$5,070
64"	82"	23" or 29"	23" or 29"	18"	\$4,455	\$5,070
70"	64"	23" or 29"	23" or 29"	18"	\$4,455	\$5,070
70"	70"	23" or 29"	23" or 29"	18"	\$4,455	\$5,070
70"	76"	23" or 29"	23" or 29"	18"	\$4,455	\$5,070
70"	82"	23" or 29"	23" or 29"	18"	\$4,455	\$5,070
76"	64"	23" or 29"	23" or 29"	18"	\$4,455	\$5,070
76"	70"	23" or 29"	23" or 29"	18"	\$4,455	\$5,070
76"	76"	23" or 29"	23" or 29"	18"	\$4,455	\$5,070
76"	82"	23" or 29"	23" or 29"	18"	\$4,455	\$5,070
82"	64"	23" or 29"	23" or 29"	18"	\$4,455	\$5,070
82"	70"	23" or 29"	23" or 29"	18"	\$4,455	\$5,070
82"	76"	23" or 29"	23" or 29"	18"	\$4,455	\$5,070
82"	82"	23" or 29"	23" or 29"	18"	\$4,455	\$5,070



ORDER CODE SAMPLE							
ITEM CODE	A SIDE	WIDTH	DEPTH	B SIDE	LAMINATE	HAND	OPTION
MWCLEL	23	82	76	23	M1	ML	LMP

Features & Specifications

No Charge Options

Optional Extra

- Leg provides 1" of leveling
- Laminate codes - M1: 1" LPL, H1: 1" HPL (top only)
- Woodgrain runs width wise if applicable
- Specify hand - "MR" main right extended, "ML" main left extended
- The BIFMA height range is 22.75" to 48.75" including the 1" top
- Available in all standard laminates
- Available in standard metal paint finishes
- For sizes not listed, specify actual (not nominal) size in product code
- For strait front instead of curved front add "SF" to option code
- For 3" grommet (AG30A), add option code(s) 'GL', 'GC' and/or 'GR', add +\$86 per grommet
- For laminate modesty panel, add option code 'LMP' and +\$386

PRODUCT MAP
TABLE OF CONTENTS
MESA ELECTRIC
VIVA ELECTRIC
VIVA MANUAL
VIVA INCREMENTAL
VIVA FIXED HEIGHT
SOHO
NOLITA
CONTROLLERS
www.brc.group

Mesa 2pc Top 3 Leg Electric C Base Table Sit-Stand

MWSCCEL

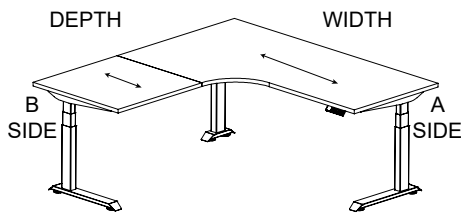

MR
MAIN RIGHT EXTENDED

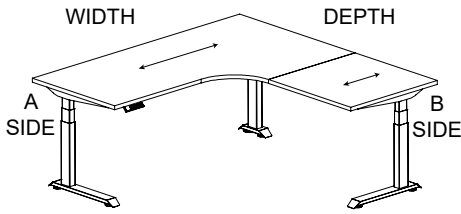

ML
MAIN LEFT EXTENDED

ARROWS INDICATE GRAIN DIRECTION
(IF APPLICABLE)

ACTUAL SIZE					LAMINATE	
WIDTH	DEPTH	A SIDE	B SIDE	RADIUS	PRICE M1	PRICE H1
64"	64"	23" or 29"	23" or 29"	18"	\$4,455	\$5,070
64"	70"	23" or 29"	23" or 29"	18"	\$4,455	\$5,070
64"	76"	23" or 29"	23" or 29"	18"	\$4,455	\$5,070
64"	82"	23" or 29"	23" or 29"	18"	\$4,455	\$5,070
70"	64"	23" or 29"	23" or 29"	18"	\$4,455	\$5,070
70"	70"	23" or 29"	23" or 29"	18"	\$4,455	\$5,070
70"	76"	23" or 29"	23" or 29"	18"	\$4,455	\$5,070
70"	82"	23" or 29"	23" or 29"	18"	\$4,455	\$5,070
76"	64"	23" or 29"	23" or 29"	18"	\$4,455	\$5,070
76"	70"	23" or 29"	23" or 29"	18"	\$4,455	\$5,070
76"	76"	23" or 29"	23" or 29"	18"	\$4,455	\$5,070
76"	82"	23" or 29"	23" or 29"	18"	\$4,455	\$5,070
82"	64"	23" or 29"	23" or 29"	18"	\$4,455	\$5,070
82"	70"	23" or 29"	23" or 29"	18"	\$4,455	\$5,070
82"	76"	23" or 29"	23" or 29"	18"	\$4,455	\$5,070
82"	82"	23" or 29"	23" or 29"	18"	\$4,455	\$5,070



ORDER CODE SAMPLE							
ITEM CODE	A SIDE	WIDTH	DEPTH	B SIDE	LAMINATE	HAND	OPTION
MWSCCEL	23	82	76	23	M1	ML	LMP

Features & Specifications

No Charge Options

Optional Extra

- Leg provides 1" of leveling
- Laminate codes - M1: 1" LPL, H1: 1" HPL (top only)
- Woodgrain runs width wise if applicable
- Specify hand - "MR" main right extended, "ML" main left extended
- The height range is 25" to 51" including the 1" top
- Available in all standard laminates
- Available in standard metal paint finishes
- For sizes not listed, specify actual (not nominal) size in product code
- For strait front instead of curved front add "SF" to option code
- For 3" grommet (AG30A), add option code(s) 'GL', 'GC' and/or 'GR', add +\$86 per grommet
- For laminate modesty panel, add option code 'LMP' and +\$386

PRODUCT MAP
TABLE OF CONTENTS
MESA ELECTRIC
VIVA ELECTRIC
VIVA MANUAL
VIVA INCREMENTAL
VIVA FIXED HEIGHT
SOHO
NOLITA
CONTROLLERS
www.brc.group

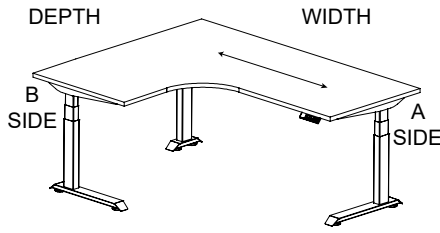

MR
MAIN RIGHT EXTENDED

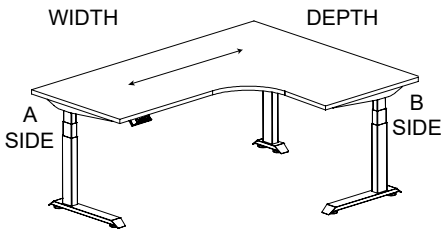

ML
MAIN LEFT EXTENDED

ARROWS INDICATE GRAIN DIRECTION
(IF APPLICABLE)

ACTUAL SIZE					LAMINATE	
WIDTH	DEPTH	A SIDE	B SIDE	RADIUS	PRICE M1	PRICE H1
58"	40"	23"	23" or 29"	12"	\$4,268	\$4,559
64"	40"	23"	23" or 29"	12"	\$4,268	\$4,559
70"	40"	23"	23" or 29"	12"	\$4,268	\$4,559
76"	40"	23"	23" or 29"	12"	\$4,268	\$4,559
82"	40"	23"	23" or 29"	12"	\$4,268	\$4,559
58"	46"	23"	23" or 29"	18"	\$4,281	\$4,574
64"	46"	23"	23" or 29"	18"	\$4,281	\$4,574
70"	46"	23"	23" or 29"	18"	\$4,281	\$4,574
76"	46"	23"	23" or 29"	18"	\$4,281	\$4,574
82"	46"	23"	23" or 29"	18"	\$4,281	\$4,574
58"	52"	23" or 29"	23" or 29"	18"	\$4,298	\$4,589
64"	52"	23" or 29"	23" or 29"	18"	\$4,298	\$4,589
70"	52"	23" or 29"	23" or 29"	18"	\$4,298	\$4,589
76"	52"	23" or 29"	23" or 29"	18"	\$4,298	\$4,589
82"	52"	23" or 29"	23" or 29"	18"	\$4,298	\$4,589
64"	58"	23" or 29"	23" or 29"	18"	\$4,312	\$4,605
70"	58"	23" or 29"	23" or 29"	18"	\$4,312	\$4,605
76"	58"	23" or 29"	23" or 29"	18"	\$4,312	\$4,605
82"	58"	23" or 29"	23" or 29"	18"	\$4,312	\$4,605



ORDER CODE SAMPLE							
ITEM CODE	A SIDE	WIDTH	DEPTH	B SIDE	LAMINATE	HAND	OPTION
MWCLEC	29	82	52	29	M1	ML	LMP

Features & Specifications

No Charge Options

Optional Extra

- Leg provides 1" of leveling
- Laminate codes - M1: 1" LPL, H1: 1" HPL (top only)
- Woodgrain runs width wise if applicable
- Specify hand - "MR" main right extended, "ML" main left extended
- The BIFMA height range is 22.75" to 48.75" including the 1" top
- Available in all standard laminates
- Available in standard metal paint finishes
- For sizes not listed, specify actual (not nominal) size in product code
- For strait front instead of curved front add "SF" to option code
- For 3" grommet (AG30A), add option code(s) 'GL', 'GC' and/or 'GR', add +\$86 per grommet
- For laminate modesty panel, add option code 'LMP' and +\$386

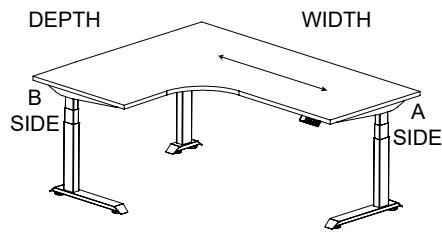

MR
MAIN RIGHT EXTENDED

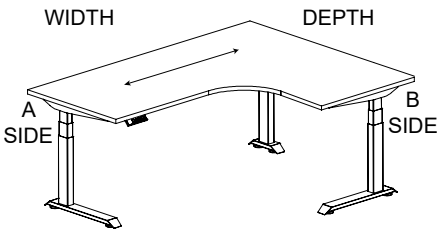

ML
MAIN LEFT EXTENDED

ARROWS INDICATE GRAIN DIRECTION
(IF APPLICABLE)

ACTUAL SIZE					LAMINATE	
WIDTH	DEPTH	A SIDE	B SIDE	RADIUS	PRICE M1	PRICE H1
58"	40"	23"	23" or 29"	12"	\$4,268	\$4,559
64"	40"	23"	23" or 29"	12"	\$4,268	\$4,559
70"	40"	23"	23" or 29"	12"	\$4,268	\$4,559
76"	40"	23"	23" or 29"	12"	\$4,268	\$4,559
82"	40"	23"	23" or 29"	18"	\$4,268	\$4,559
58"	46"	23"	23" or 29"	18"	\$4,281	\$4,574
64"	46"	23"	23" or 29"	18"	\$4,281	\$4,574
70"	46"	23"	23" or 29"	18"	\$4,281	\$4,574
76"	46"	23"	23" or 29"	18"	\$4,281	\$4,574
82"	46"	23"	23" or 29"	18"	\$4,281	\$4,574
58"	52"	23" or 29"	23" or 29"	18"	\$4,298	\$4,589
64"	52"	23" or 29"	23" or 29"	18"	\$4,298	\$4,589
70"	52"	23" or 29"	23" or 29"	18"	\$4,298	\$4,589
76"	52"	23" or 29"	23" or 29"	18"	\$4,298	\$4,589
82"	52"	23" or 29"	23" or 29"	18"	\$4,298	\$4,589
64"	58"	23" or 29"	23" or 29"	18"	\$4,312	\$4,605
70"	58"	23" or 29"	23" or 29"	18"	\$4,312	\$4,605
76"	58"	23" or 29"	23" or 29"	18"	\$4,312	\$4,605
82"	58"	23" or 29"	23" or 29"	18"	\$4,312	\$4,605



ORDER CODE SAMPLE							
ITEM CODE	A SIDE	WIDTH	DEPTH	B SIDE	LAMINATE	HAND	OPTION
MWCLEC	29	82	46	29	M1	ML	LMP

Features & Specifications

No Charge Options

Optional Extra

- Leg provides 1" of leveling
- Laminate codes - M1: 1" LPL, H1: 1" HPL (top only)
- Woodgrain runs width wise if applicable
- Specify hand - "MR" main right extended, "ML" main left extended
- The height range is 25" to 51" including the 1" top
- Available in all standard laminates
- Available in standard metal paint finishes
- For sizes not listed, specify actual (not nominal) size in product code
- For strait front instead of curved front add "SF" to option code
- For 3" grommet (AG30A), add option code(s) 'GL', 'GC' and/or 'GR', add +\$86 per grommet
- For laminate modesty panel, add option code 'LMP' and +\$386

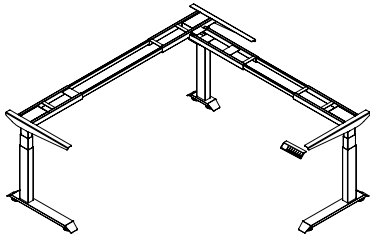

MWCL3BO	
FEATURES & SPECIFICATIONS	PRICE
<ul style="list-style-type: none"> Accommodates worksurface sizes of 48" - 84" wide, returns 48" to 84" wide 24" - 30" deep, and depths 24" - 30" 	\$3,220

Features & Specifications

No Charge Options



ORDER CODE SAMPLE
ITEM CODE
MWCL3BO

- Leg provides 1" of leveling
 - All kits include base frame, feet, levellers and Mesa handset controller
 - Assembly instructions included in box
 - Worksurface fastening hardware not included. Screws should be chosen by the installer taking into account the thickness of worksurface used
 - The BIFMA height range is 22.75" to 48.75" including the 1" top
-
- Available in standard metal paint finishes

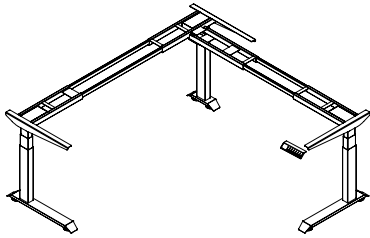

MWCL3BO	
FEATURES & SPECIFICATIONS	PRICE
<ul style="list-style-type: none"> Accommodates worksurface sizes of 48" - 84" wide, returns 48" to 84" wide 24" - 30" deep, and depths 24" - 30" 	\$3,220

Features & Specifications

No Charge Options



ORDER CODE SAMPLE
ITEM CODE
MWCL3BO

- Leg provides 1" of leveling
 - All kits include base frame, feet, levellers and Mesa handset controller
 - Assembly instructions included in box
 - Worksurface fastening hardware not included. Screws should be chosen by the installer taking into account the thickness of worksurface used
 - The height range is 25" to 51" including the 1" top
-
- Available in standard metal paint finishes

Mesa Rectangular 2 Leg Fixed C Base Table

MFMCH

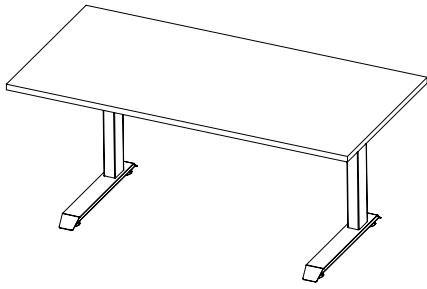

ACTUAL SIZE				LAMINATE	
WIDTH	DEPTH	HEIGHT	WEIGHT	PRICE M1	PRICE H1
24"	24"	29"	85	\$1,553	\$1,625
30"	24"	29"	88	\$1,553	\$1,625
36"	24"	29"	92	\$1,553	\$1,625
42"	24"	29"	95	\$1,553	\$1,625
48"	24"	29"	97	\$1,553	\$1,625
48"	30"	29"	102	\$1,684	\$1,827
60"	24"	29"	102	\$1,684	\$1,827
60"	30"	29"	109	\$1,948	\$2,236
66"	24"	29"	104	\$1,684	\$1,827
66"	30"	29"	113	\$1,948	\$2,236
72"	24"	29"	107	\$1,684	\$1,827
72"	30"	29"	116	\$1,948	\$2,236
78"	24"	29"	110	\$1,684	\$1,827
78"	30"	29"	119	\$1,948	\$2,236
84"	24"	29"	113	\$1,684	\$1,827
84"	30"	29"	123	\$1,948	\$2,236
84"	36"	29"	132	\$1,948	\$2,236



ORDER CODE SAMPLE					
ITEM CODE	WIDTH	DEPTH	HEIGHT	LAMINATE	OPTION
MFMCH	72	24	29	H1	LMP

Features & Specifications

- Leg provides 1" of leveling
- Laminate codes - M1: 1" LPL, H1: 1" HPL (top only)
- Woodgrain runs width wise if applicable

No Charge Options

- Available in all standard laminates
- Available in standard metal paint finishes
- For sizes not listed, specify actual (not nominal) size in product code

Optional Extra

- For 3" grommet (AG30A), add option code(s) 'GL', 'GC' and/or 'GR', add +\$86 per grommet
- For laminate modesty panel, add option code 'LMP' and +\$313



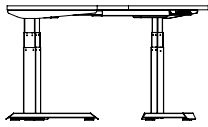
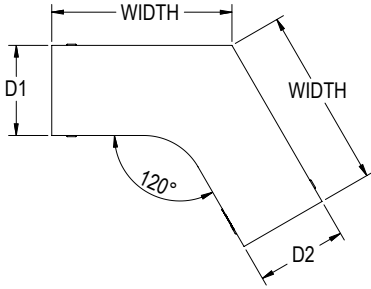
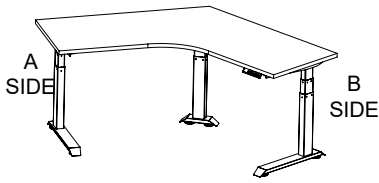

ACTUAL SIZE			LAMINATE	
WIDTH	A SIDE	B SIDE	PRICE M1	PRICE H1
34"	23" or 29"	23" or 29"	\$4,351	\$4,964
40"	23" or 29"	23" or 29"	\$4,351	\$4,964
46"	23" or 29"	23" or 29"	\$4,351	\$4,964
52"	23" or 29"	23" or 29"	\$4,351	\$4,964
58"	23" or 29"	23" or 29"	\$4,351	\$4,964

Features & Specifications

No Charge Options

Optional Extra



ORDER CODE SAMPLE					
ITEM CODE	A SIDE	WIDTH	B SIDE	LAMINATE	OPTION
MFCTH	A23	W72	B29	H1	LMP

- Leg provides 1" of leveling
- Laminate codes - M1: 1" LPL, H1: 1" HPL (top only)
- Worksurface may have a seam
- The BIFMA height range is 22.75" to 48.75" including the 1" top

- Available in all standard laminates
- Available in standard metal paint finishes
- For sizes not listed, specify actual (not nominal) size in product code

- For 3" grommet (AG30A), add option code(s) 'GL', 'GC' and/or 'GR', add +\$86 per grommet
- For laminate modesty panel, add option code 'LMP' and +\$493

Mesa 120 Degree 3 Leg Electric C Base Table Sit-Stand MFSTCTH

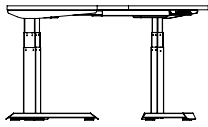
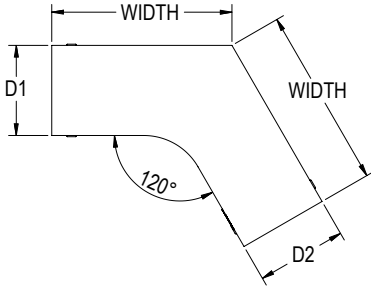
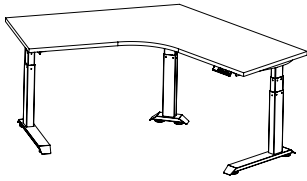

ACTUAL SIZE			LAMINATE	
WIDTH	A SIDE	B SIDE	PRICE M1	PRICE H1
34"	23" or 29"	23" or 29"	\$4,351	\$4,964
40"	23" or 29"	23" or 29"	\$4,351	\$4,964
46"	23" or 29"	23" or 29"	\$4,351	\$4,964
52"	23" or 29"	23" or 29"	\$4,351	\$4,964
58"	23" or 29"	23" or 29"	\$4,351	\$4,964

Features & Specifications

No Charge Options

Optional Extra



ORDER CODE SAMPLE					
ITEM CODE	A SIDE	WIDTH	B SIDE	LAMINATE	OPTION
MFCTH	A23	W72	B29	H1	LMP

- Leg provides 1" of leveling
- Laminate codes - M1: 1" LPL, H1: 1" HPL (top only)
- Worksurface may have a seam
- The BIFMA height range is 25" to 51" including the 1" top

- Available in all standard laminates
- Available in standard metal paint finishes
- For sizes not listed, specify actual (not nominal) size in product code

- For 3" grommet (AG30A), add option code(s) 'GL', 'GC' and/or 'GR', add +\$86 per grommet
- For laminate modesty panel, add option code 'LMP' and +\$493

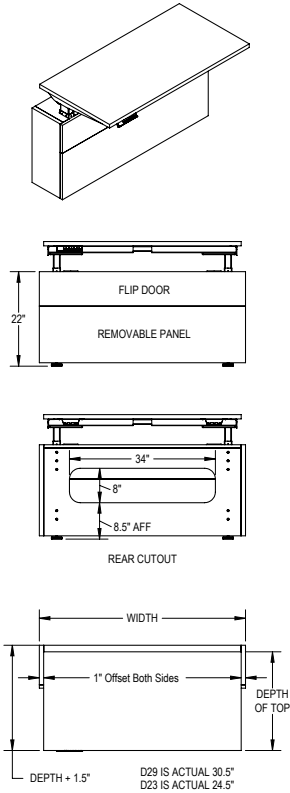

APPLICATION

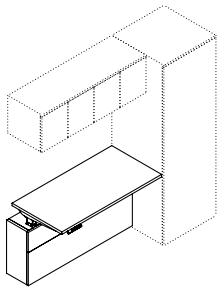

Features & Specifications

No Charge Options

ACTUAL SIZE		LAMINATE	
OVERALL WIDTH	WORKSURFACE DEPTH	PRICE <i>M1</i>	PRICE <i>H1</i>
48"	23"	\$4,961	\$5,129
60"	23"	\$5,016	\$5,182
72"	23"	\$5,069	\$5,235
78"	23"	\$5,122	\$5,289
48"	29"	\$5,016	\$5,182
60"	29"	\$5,069	\$5,235
72"	29"	\$5,122	\$5,289
78"	29"	\$5,122	\$5,289



ORDER CODE SAMPLE			
ITEM CODE	WIDTH	DEPTH	LAMINATE
MMWHH	72	23	<i>M1</i>

- For wall mount applications only
- Laminate codes - *M1*: 1" LPL, *H1*: 1" HPL (top only)
- Woodgrain runs width wise if applicable
- Includes wire management from desk to base
- Includes flip down upper front door for wire access
- Laminate base measures 22" high x 10" deep
- Width indicates laminate base width, worksurface is 2" less (1" on each side)
- Listed depth reflects the top surface only. The overall unit extends an additional 1.5" beyond this measurement.
- The height range is 26" to 51.5" including the 1" top
- Available in all standard laminates
- Base available in standard metal paint finishes

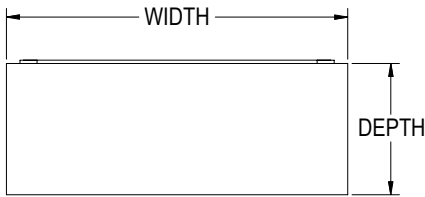
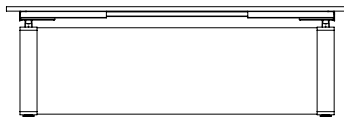
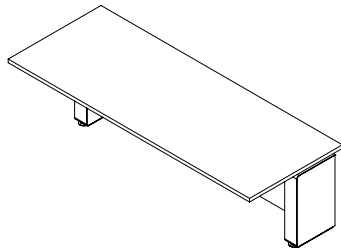

ACTUAL SIZE		LAMINATE	
WIDTH	DEPTH	PRICE <i>M1</i>	PRICE <i>H1</i>
48"	24"	\$4,486	\$4,652
60"	24"	\$4,539	\$4,707
72"	24"	\$4,594	\$4,759
78"	24"	\$4,648	\$4,813
48"	30"	\$4,539	\$4,707
60"	30"	\$4,594	\$4,759
72"	30"	\$4,648	\$4,813
78"	30"	\$4,700	\$4,868

Features & Specifications

No Charge Options



ORDER CODE SAMPLE			
ITEM CODE	WIDTH	DEPTH	LAMINATE
MMWBH	72	24	<i>M1</i>

- For wall mount applications only
 - Laminate codes - *M1*: 1" LPL, *H1*: 1" HPL (top only)
 - Woodgrain runs width wise if applicable
 - Includes recessed removable front modesty for wire access
 - Wire slot in base open across top
 - Metal wrapped end bases are 21" high x 12.5" deep with laminate side covers
 - Recessed center modesty is 4" deep.
 - Worksurface is 6" wider (3" each side) than lower base width
-
- Available in all standard laminates
 - Base available in standard metal paint finishes

Summary

The Amplify Telescoping Metal Surround is specifically designed to encase the T-leg of Mesa Height Adjustable Tables. When installing the surround, the foot and the upper cantilever of the T-leg must be removed. Due to this design detail, there are specific application guidelines that must be followed to ensure proper support. Please refer to the application layouts below for guidance.

 Surround can only be used with T-leg Mesa Height Adjustable Tables

Correct Applications:

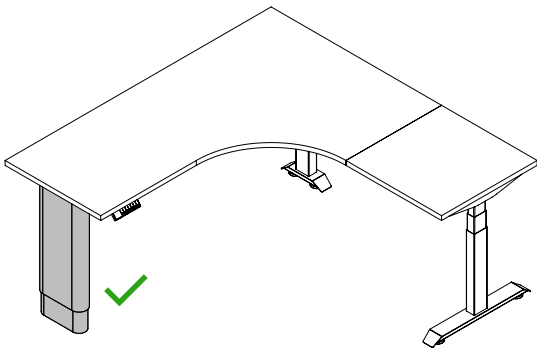
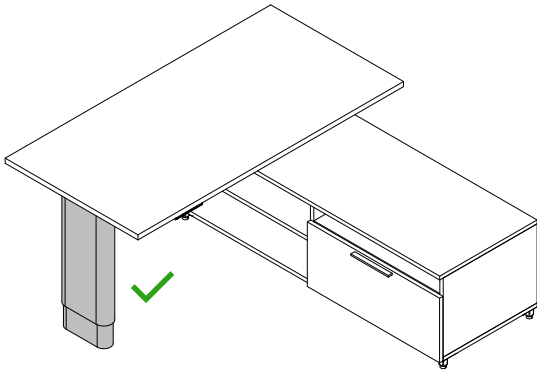

Incorrect Applications:

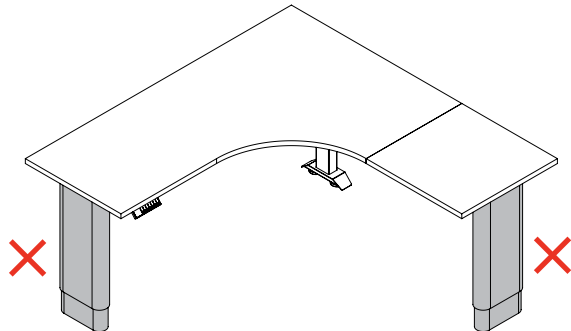
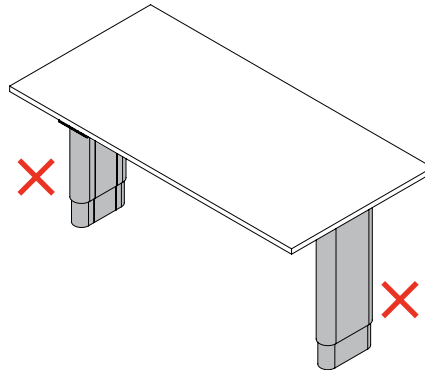
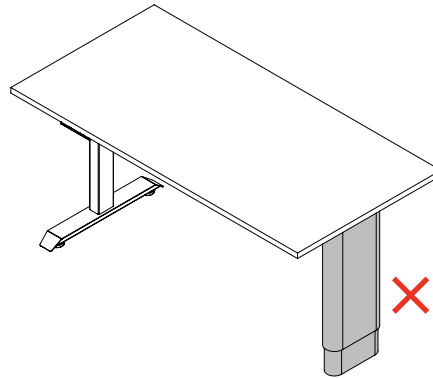

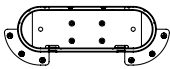
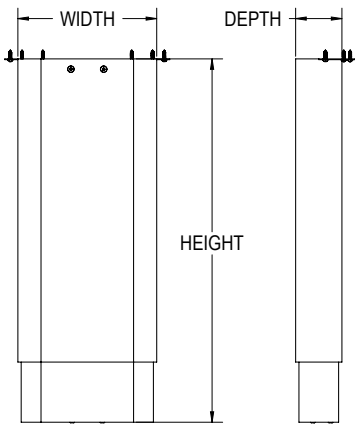
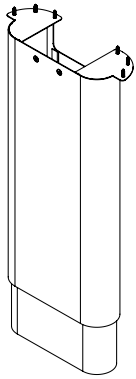

OVERALL SIZE			
WIDTH	DEPTH	HEIGHT	PRICE
10.5"	3.5"	25" - 44"	\$727

Features & Specifications

No Charge Options



SPECIAL NOTES



ORDER CODE SAMPLE
ITEM CODE
MWATA

- 16 gauge steel construction for upper and lower sleeve with one inch of leveling
- 3/4" fasteners included
- Accommodates 23" & 29" deep BRC Mesa Sit-Stand Height Adjustable T leg configuration only
- Can not be used in a freestanding application
- The surround can be retrofitted on existing BRC Mesa Sit-Stand Height Adjustable bases (T leg only) directly in the field

- Available in silver finish only

- Handset requires reprogramming as per page 2 of install guide

Viva

Premium Electric Height Adjustable Tables

Standard Features:

- LPL & HPL Worksurfaces available with overall height adjustability from 22.25" to 48.25"
- Dual motor with a lift capacity up to 300lbs and 1.5" [38.1mm] per second travel
- Anti collision piezoelectric sensor stops movement when obstruction is encountered
- Power ratings: 450W, 3.75 Amp working, 0.1W standby. 125" Cord length
- C Base two and three leg table configurations
- Whisper quiet motion at only 55 decibels
- Foot design matches all Viva line product

Optional Features:

- Bluetooth with Desk Control App
- Rechargeable Battery for wireless operation
- Multiple handset options
- Left, right and center grommets
- Keyboard tray adaptable
- Modesty panel is 10" high

Basic Dimensions:

C-LEG

- Column: 2" x 3" [50.8mm x 76.2mm]
- Foot: 2.88" x 24" [73.2mm x 609.6mm]
- Foot height: 1.375" [34.9mm]

Finishes:

BASE

- Powdercoat silver, black & white

WORKSURFACE

- 1" or 1.5" LPL & HPL in all standard BRC laminates

General Product Overview:

Table bases are metal and have a durable scratch resistant, heat cured powder coat paint finish. Metal uprights are of 14 gauge tubing 2" thick by 3" wide. Low profile foot is constructed of drawn steel, with waterfall front and back edges. The interior of the foot is double walled with 11 gauge steel supports. These feet have easy to access levelers for ease of installation and balancing. ANSI Bifma and CGSB (Canadian General Standards Board) tested and qualified. This ensures that BRC products adhere to the highest standards of quality and durability in North America. UL Certified electronics.

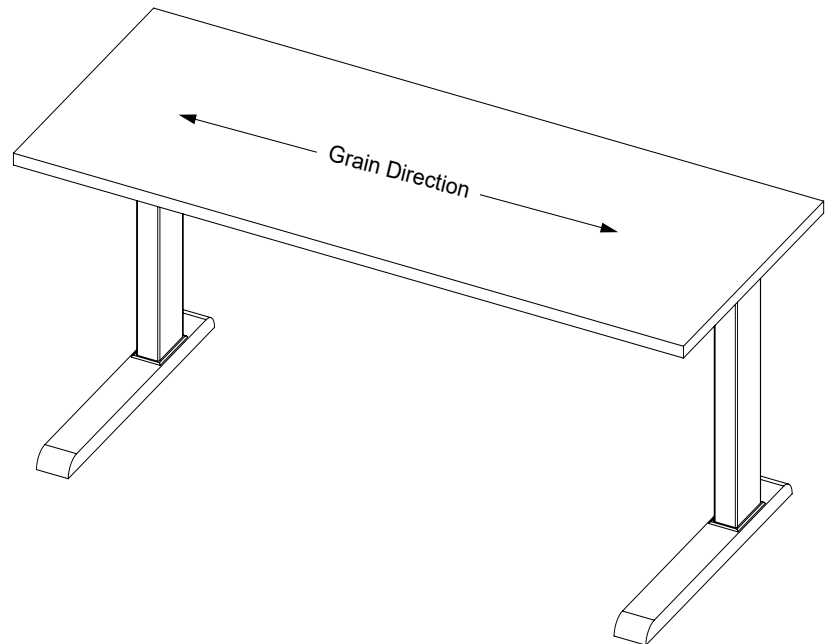

Viva Rectangular 2 Leg Electric C Base Table

MWEE

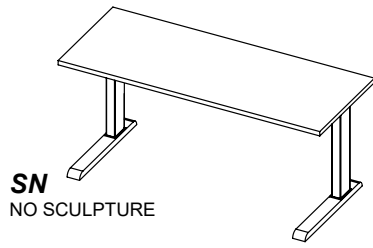

SN
NO SCULPTURE

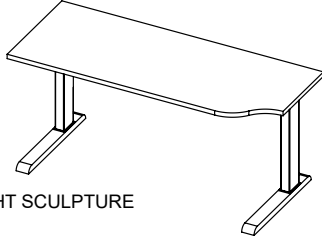

SR
RIGHT SCULPTURE

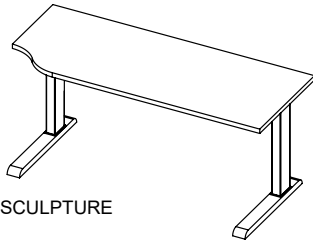

SL
LEFT SCULPTURE

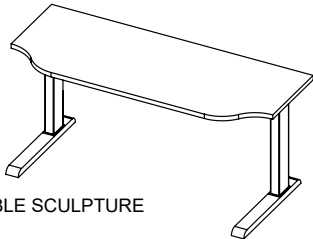

SD
DOUBLE SCULPTURE

Features & Specifications

No Charge Options

Optional Extra

ACTUAL SIZE			LAMINATE	
WIDTH	DEPTH	WEIGHT/CUBE	PRICE M1	PRICE H1
28"	23"	70/30	\$3,096	\$3,159
34"	23"	70/30	\$3,112	\$3,177
40"	23"	80/36	\$3,169	\$3,221
46"	23"	90/48	\$3,207	\$3,269
58"	23"	100/48	\$3,389	\$3,442
64"	23"	105/60	\$3,517	\$3,598
70"	23"	115/72	\$3,661	\$3,727
76"	23"	115/72	\$3,882	\$3,946
82"	23"	120/76	\$4,083	\$4,138
94"	23"	140/85	\$4,813	\$4,871
28"	29"	75/30	\$3,299	\$3,360
34"	29"	85/36	\$3,352	\$3,406
40"	29"	95/48	\$3,389	\$3,450
46"	29"	105/48	\$3,571	\$3,625
58"	29"	110/60	\$3,698	\$3,780
64"	29"	110/60	\$3,844	\$3,910
70"	29"	110/72	\$3,844	\$3,910
76"	29"	110/72	\$4,066	\$4,130
82"	29"	120/72	\$4,265	\$4,320
82"	35"	120/72	\$4,813	\$4,871



ORDER CODE SAMPLE					
ITEM CODE	WIDTH	DEPTH	LAMINATE	SCULPTURE	OPTION
MWEE	70	23	H1	SN	LMP

- Leg provides 1" of leveling
- Laminate codes - M1: 1" LPL, H1: 1" HPL (top only)
- Specify sculpture - 'SN' - none, 'SR' - right, 'SL' - left, or 'SD' - double
- Woodgrain runs horizontally if applicable
- Sculpture is 6" deep (eg: 23" depth is 17" at edge when sculptured)

- Available in all standard laminates
- Available in standard metal paint finishes
- For sizes not listed, specify actual (not nominal) size in product code

- For 3" grommet (AG30A), add option code(s) 'GL', 'GC' and/or 'GR', add +\$86 per grommet
- For laminate modesty panel, add option code 'LMP' and +\$313
- For 6" Bow fronts on tables 58" and larger; add option code 'BF' and +\$242

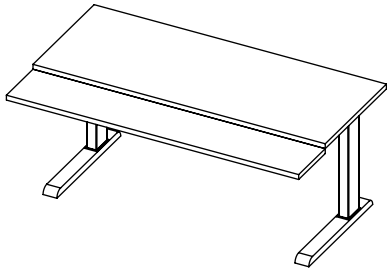

DUAL ARM KEYBOARD

ACTUAL SIZE			LAMINATE	
WIDTH	DEPTH	WEIGHT/CUBE	PRICE M1	PRICE H1
40"	29"	100/60	\$5,028	\$5,307
46"	29"	106/60	\$5,165	\$5,455
58"	29"	115/70	\$5,535	\$5,855
58"	35"	115/70	\$5,535	\$5,855

Features & Specifications

No Charge Options

Optional Extra



ORDER CODE SAMPLE				
ITEM CODE	WIDTH	DEPTH	LAMINATE	OPTION
MTEE	58	29	H1	KW(FOC)

- Leg provides 1" of leveling
- Laminate codes - M1: 1" LPL, H1: 1" HPL (top only)
- Default KBKW-27 dual arm keyboard mechanism has a range of 9.5" Above and 6.5" Below work-surface with 15 degrees positive or negative tilt
- Woodgrain runs horizontally if applicable
- Available in all standard laminates
- Available in standard metal paint finishes
- For sizes not listed, specify actual (not nominal) size in product code
- For 3" grommet (AG30A), add option code(s) 'GL', 'GC' and/or 'GR', add +\$86 per grommet
- For laminate modesty panel, add option code 'LMP' and +\$313
- For sliding keyboard with 5" of adjustment; add option code 'KW(FOC)' and +\$474

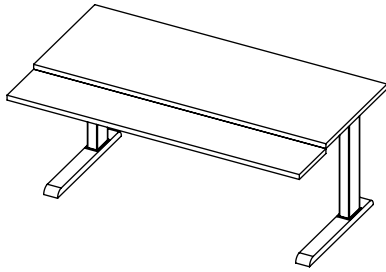

SINGLE ARM KEYBOARD

ACTUAL SIZE			LAMINATE	
WIDTH	DEPTH	WEIGHT/CUBE	PRICE M1	PRICE H1
28"	29"	95/50	\$4,473	\$4,888
34"	29"	89/40	\$4,527	\$4,762

Features & Specifications

No Charge Options

Optional Extra



ORDER CODE SAMPLE				
ITEM CODE	WIDTH	DEPTH	LAMINATE	OPTION
MTEESA	34	29	H1	KW(FOC)

- Leg provides 1" of leveling
- Laminate codes - M1: 1" LPL, H1: 1" HPL (top only)
- Default KBSS single arm keyboard mechanism has a range of 6" above and 6" below worksurface with 15 degrees positive or negative tilt
- Woodgrain runs horizontally if applicable
- Available in all standard laminates
- Available in standard metal paint finishes
- For sizes not listed, specify actual (not nominal) size in product code
- For 3" grommet (AG30A), add option code(s) 'GL', 'GC' and/or 'GR', add +\$86 per grommet
- For laminate modesty panel, add option code 'LMP' and +\$313



A1
STRAIGHT FRONT
CURVE BACK

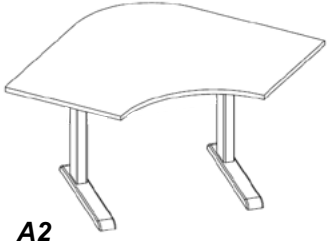

A2
CURVE FRONT
CURVE BACK

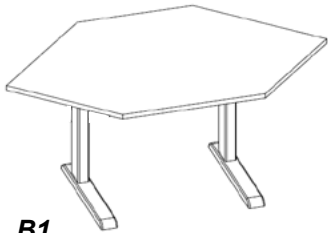

B1
STRAIGHT FRONT
STRAIGHT BACK

Features & Specifications

No Charge Options

Optional Extra

ACTUAL SIZE				LAMINATE	
WIDTH	DEPTH	USER WIDTH	WEIGHT/ CUBE	PRICE M1	PRICE H1
28"	23"	9"	90/54	\$3,763	\$3,938
34"	23"	17"	90/54	\$3,854	\$4,028
40"	23"	25"	100/60	\$4,219	\$4,394
46"	23"	34"	105/60	\$4,403	\$4,468
40"	29"	17"	105/60	\$4,304	\$4,487
46"	29"	25"	105/60	\$4,394	\$4,576



ORDER CODE SAMPLE					
ITEM CODE	WIDTH	DEPTH	LAMINATE	STYLE	OPTION
MTKEE	46	29	H1	A1	LMP

- Leg provides 1" of leveling
- Laminate codes - M1: 1" LPL, H1: 1" HPL (top only)
- Specify worksurface style: 'A1', 'A2' or 'B1'

- Available in all standard laminates
- Available in standard metal paint finishes
- For sizes not listed, specify actual (not nominal) size in product code

- For 3" grommet (AG30A), add option code(s) 'GL', 'GC' and/or 'GR', add +\$86 per grommet
- For laminate modesty panel, add option code 'LMP' and +\$313

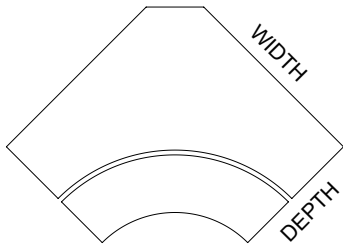
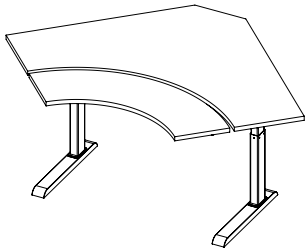

ACTUAL SIZE			LAMINATE	
WIDTH	DEPTH	WEIGHT/CUBE	PRICE M1	PRICE H1
40"	17"	100/60	\$5,451	\$5,765
40"	23"	100/60	\$5,451	\$5,765
46"	23"	105/60	\$5,535	\$5,855
46"	29"	105/60	\$5,626	\$5,950

Features & Specifications

No Charge Options

Optional Extra



ORDER CODE SAMPLE				
ITEM CODE	WIDTH	DEPTH	LAMINATE	OPTION
MTKKEEVC	46	29	H1	LMP

- Leg provides 1" of leveling
- Laminate codes - M1: 1" LPL, H1: 1" HPL (top only)
- Default KBKW dual arm keyboard mechanism has a range of 9.5" above and 6.5" below worksurface with 15 degrees positive or negative tilt

- Available in all standard laminates
- Available in standard metal paint finishes
- For sizes not listed, specify actual (not nominal) size in product code
- Straight front available; add option SF to product code

- For 3" grommet (AG30A), add option code(s) 'GL', 'GC' and/or 'GR', add +\$86 per grommet
- For laminate modesty panel, add option code 'LMP' and +\$313
- For sliding keyboard with 5" of adjustment; add option code 'KW(FOC)' and +\$519

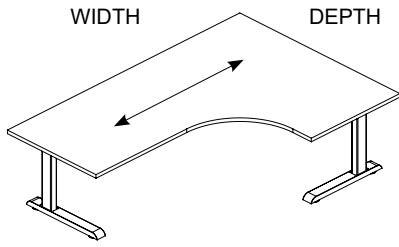

EL
EXTENDED LEFT

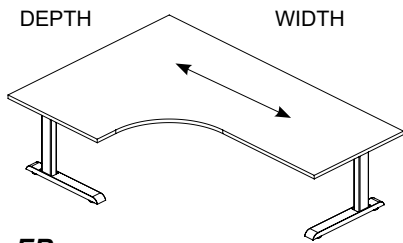

ER
EXTENDED RIGHT

23" DEEP RETURN ON BOTH SIDES

ARROWS INDICATE GRAIN DIRECTION (IF APPLICABLE)

ACTUAL SIZE					LAMINATE	
WIDTH	DEPTH	RETURN	RADIUS	WT/CUBE	PRICE M1	PRICE H1
58"	46"	23"	18"	149/11.0	\$5,579	\$5,965
64"	46"	23"	18"	176/14.6	\$5,615	\$6,005
70"	46"	23"	18"	189/15.9	\$5,615	\$6,005
76"	46"	23"	18"	202/17.2	\$5,637	\$6,027
82"	46"	23"	18"	215/18.5	\$5,637	\$6,027
58"	52"	23"	18"	149/11.0	\$5,653	\$6,042
64"	52"	23"	18"	176/14.6	\$5,683	\$6,070
70"	52"	23"	18"	189/15.9	\$5,683	\$6,070
76"	52"	23"	18"	202/17.2	\$5,741	\$6,127
82"	52"	23"	18"	215/18.5	\$5,741	\$6,127
64"	58"	23"	18"	176/14.6	\$5,741	\$6,127
70"	58"	23"	18"	189/15.9	\$5,853	\$6,242
76"	58"	23"	18"	202/17.2	\$6,007	\$6,393
82"	58"	23"	18"	215/18.5	\$6,056	\$6,442



ORDER CODE SAMPLE							
ITEM CODE	RETURN	WIDTH	DEPTH	RETURN	LAMINATE	HAND	OPTION
MWEEC	23	70	46	23	M1	EL	GC

Features & Specifications

No Charge Options

Optional Extra

- Leg provides 1" of leveling
- Laminate codes - M1: 1" LPL, H1: 1" HPL (top only)
- Woodgrain runs horizontally on the longest side of the table
- Specify style - 'ER' - extended right, or 'EL' - extended left

- Available in all standard laminates
- Available in standard metal paint finishes
- For sizes not listed, specify actual (not nominal) size in product code
- For straight front instead of standard curved, add code SF to options

- For 3" grommet (AG30A), add option code(s) 'GL', 'GC' and/or 'GR', add +\$86 per grommet
- For laminate modesty panel, add option code 'LMP' and +\$386

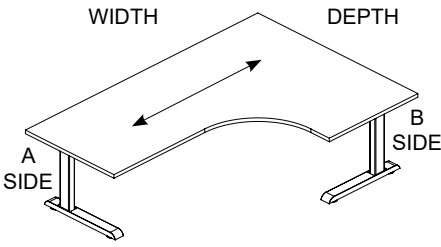

ML
MAIN LEFT EXTENDED

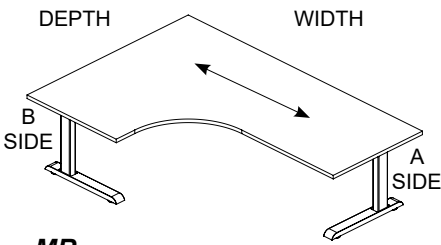

MR
MAIN RIGHT EXTENDED

ARROWS INDICATE GRAIN DIRECTION
(IF APPLICABLE)

ACTUAL SIZE						LAMINATE	
WIDTH	DEPTH	A SIDE	B SIDE	RADIUS	WT/CUBE	PRICE M1	PRICE H1
58"	46"	23"	23" or 29"	18"	149/11.0	\$5,930	\$6,348
64"	46"	23"	23" or 29"	18"	176/14.6	\$5,972	\$6,379
70"	46"	23"	23" or 29"	18"	189/15.9	\$5,972	\$6,379
76"	46"	23"	23" or 29"	18"	202/17.2	\$5,994	\$6,407
82"	46"	23"	23" or 29"	18"	215/18.5	\$5,994	\$6,407
58"	52"	23" or 29"	23" or 29"	18"	149/11.0	\$6,010	\$6,423
64"	52"	23" or 29"	23" or 29"	18"	176/14.6	\$6,039	\$6,452
70"	52"	23" or 29"	23" or 29"	18"	189/15.9	\$6,039	\$6,452
76"	52"	23" or 29"	23" or 29"	18"	202/17.2	\$6,102	\$6,516
82"	52"	23" or 29"	23" or 29"	18"	215/18.5	\$6,102	\$6,516
64"	58"	23" or 29"	23" or 29"	18"	176/14.6	\$6,102	\$6,516
70"	58"	23" or 29"	23" or 29"	18"	189/15.9	\$6,219	\$6,632
76"	58"	23" or 29"	23" or 29"	18"	202/17.2	\$6,384	\$6,798
82"	58"	23" or 29"	23" or 29"	18"	215/18.5	\$6,436	\$6,850



ORDER CODE SAMPLE							
ITEM CODE	A SIDE	WIDTH	DEPTH	B SIDE	LAMINATE	HAND	OPTION
MWEEC	29	70	46	29	M1	ML	GC

Features & Specifications

No Charge Options

Optional Extra

- Leg provides 1" of leveling
- Laminate codes - M1: 1" LPL, H1: 1" HPL (top only)
- Woodgrain runs horizontally on the longest side of the table
- Specify style - 'MR' - extended right, or 'ML' - extended left

- Available in all standard laminates
- Available in standard metal paint finishes
- For sizes not listed, specify actual (not nominal) size in product code
- For straight front instead of standard curved, add code SF to options

- For 3" grommet (AG30A), add option code(s) 'GL', 'GC' and/or 'GR', add +\$86 per grommet
- For laminate modesty panel, add option code 'LMP' and +\$386

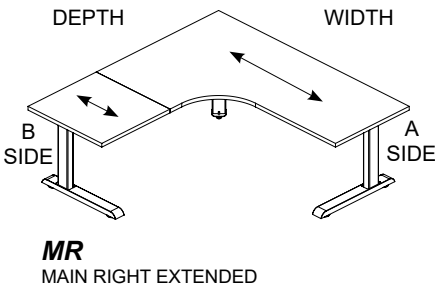
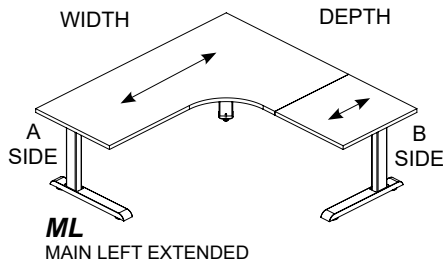

**MAIN WORKSURFACE DETERMINES
HANDEDNESS, SEAM DICTATES
RETURN**

ARROWS INDICATE GRAIN DIRECTION
(IF APPLICABLE)

Features & Specifications

No Charge Options

Optional Extra

ACTUAL SIZE						LAMINATE		
WIDTH	DEPTH	A SIDE	B SIDE	RADIUS	WT/CUBE	PRICE M1	PRICE H1	
64"	64"	23" or 29"	23" or 29"	18"	185/14.6	\$6,085	\$6,495	
64"	70"	23" or 29"	23" or 29"	18"	190/14.8	\$6,085	\$6,495	
64"	76"	23" or 29"	23" or 29"	18"	194/15.0	\$6,085	\$6,495	
64"	82"	23" or 29"	23" or 29"	18"	198/15.2	\$6,085	\$6,495	
64"	88"	23" or 29"	23" or 29"	18"	203/15.4	\$6,085	\$6,495	
64"	94"	23" or 29"	23" or 29"	18"	207/15.6	\$6,085	\$6,495	
70"	64"	23" or 29"	23" or 29"	18"	190/15.8	\$6,204	\$6,617	
70"	70"	23" or 29"	23" or 29"	18"	189/15.9	\$6,204	\$6,617	
70"	76"	23" or 29"	23" or 29"	18"	198/16.0	\$6,204	\$6,617	
70"	82"	23" or 29"	23" or 29"	18"	203/16.2	\$6,204	\$6,617	
70"	88"	23" or 29"	23" or 29"	18"	207/16.4	\$6,204	\$6,617	
70"	94"	23" or 29"	23" or 29"	18"	211/16.8	\$6,204	\$6,617	
76"	64"	23" or 29"	23" or 29"	18"	194/17.0	\$6,367	\$6,777	
76"	70"	23" or 29"	23" or 29"	18"	198/17.1	\$6,367	\$6,777	
76"	76"	23" or 29"	23" or 29"	18"	202/17.2	\$6,367	\$6,777	
76"	82"	23" or 29"	23" or 29"	18"	207/17.4	\$6,367	\$6,777	
76"	88"	23" or 29"	23" or 29"	18"	211/17.6	\$6,367	\$6,777	
76"	94"	23" or 29"	23" or 29"	18"	216/17.8	\$6,367	\$6,777	
82"	64"	23" or 29"	23" or 29"	18"	198/18.0	\$6,419	\$6,829	
82"	70"	23" or 29"	23" or 29"	18"	203/18.2	\$6,419	\$6,829	
82"	76"	23" or 29"	23" or 29"	18"	207/18.4	\$6,419	\$6,829	
82"	82"	23" or 29"	23" or 29"	18"	211/18.6	\$6,419	\$6,829	
82"	88"	23" or 29"	23" or 29"	18"	216/18.8	\$6,419	\$6,829	
82"	94"	23" or 29"	23" or 29"	18"	220/19.0	\$6,419	\$6,829	
94"	64"	23" or 29"	23" or 29"	18"	207/19.2	\$6,618	\$7,029	
94"	70"	23" or 29"	23" or 29"	18"	211/19.4	\$6,618	\$7,029	
94"	76"	23" or 29"	23" or 29"	18"	216/19.6	\$6,618	\$7,029	
94"	82"	23" or 29"	23" or 29"	18"	220/19.8	\$6,618	\$7,029	
94"	88"	23" or 29"	23" or 29"	18"	224/19.9	\$6,618	\$7,029	
94"	94"	23" or 29"	23" or 29"	18"	225/20.1	\$6,618	\$7,029	



ORDER CODE SAMPLE							
ITEM CODE	A SIDE	WIDTH	DEPTH	B SIDE	LAMINATE	HAND	OPTION
MWEEL	29	70	76	29	M1	ML	GC LMP

- Leg provides 1" of leveling
- Laminate codes - M1: 1" LPL, H1: 1" HPL (top only)
- Two piece worksurface will have a seam as shown

- Available in all standard laminates
- Available in standard metal paint finishes
- For sizes not listed, specify actual (not nominal) size in product code

- For 3" grommet (AG30A), add option code(s) 'GL', 'GC' and/or 'GR', add +\$86 per grommet
- For laminate modesty panel, add option code 'LMP' and +\$386

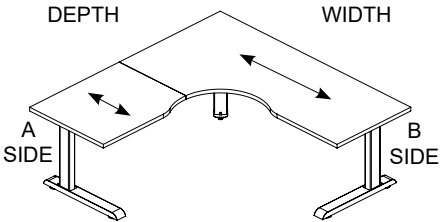

MR
MAIN RIGHT EXTENDED

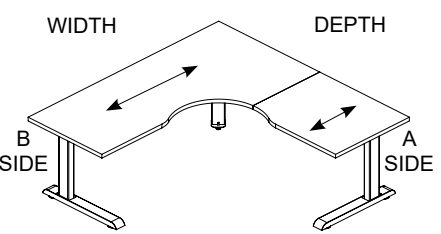

ML
MAIN LEFT EXTENDED

29" DEEP RETURN ON BOTH SIDES
MAIN WORKSURFACE DETERMINES
HANDEDNESS, SEAM DICTATES
RETURN

ARROWS INDICATE GRAIN DIRECTION
(IF APPLICABLE)

Features & Specifications

No Charge Options

Optional Extra

ACTUAL SIZE					LAMINATE		
WIDTH	DEPTH	A SIDE	B SIDE	WT/CUBE	PRICE M1	PRICE H1	
64"	64"	23" or 29"	23" or 29"	185/14.6	\$6,085	\$6,495	
64"	70"	23" or 29"	23" or 29"	190/14.8	\$6,085	\$6,495	
64"	76"	23" or 29"	23" or 29"	194/15.0	\$6,085	\$6,495	
64"	82"	23" or 29"	23" or 29"	198/15.2	\$6,085	\$6,495	
64"	88"	23" or 29"	23" or 29"	203/15.4	\$6,085	\$6,495	
64"	94"	23" or 29"	23" or 29"	207/15.6	\$6,085	\$6,495	
70"	64"	23" or 29"	23" or 29"	190/15.8	\$6,204	\$6,617	
70"	70"	23" or 29"	23" or 29"	189/15.9	\$6,204	\$6,617	
70"	76"	23" or 29"	23" or 29"	198/16.0	\$6,204	\$6,617	
70"	82"	23" or 29"	23" or 29"	203/16.2	\$6,204	\$6,617	
70"	88"	23" or 29"	23" or 29"	207/16.4	\$6,204	\$6,617	
70"	94"	23" or 29"	23" or 29"	211/16.8	\$6,204	\$6,617	
76"	64"	23" or 29"	23" or 29"	194/17.0	\$6,367	\$6,777	
76"	70"	23" or 29"	23" or 29"	198/17.1	\$6,367	\$6,777	
76"	76"	23" or 29"	23" or 29"	202/17.2	\$6,367	\$6,777	
76"	82"	23" or 29"	23" or 29"	207/17.4	\$6,367	\$6,777	
76"	88"	23" or 29"	23" or 29"	211/17.6	\$6,367	\$6,777	
76"	94"	23" or 29"	23" or 29"	216/17.8	\$6,367	\$6,777	
82"	64"	23" or 29"	23" or 29"	198/18.0	\$6,419	\$6,829	
82"	70"	23" or 29"	23" or 29"	203/18.2	\$6,419	\$6,829	
82"	76"	23" or 29"	23" or 29"	207/18.4	\$6,419	\$6,829	
82"	82"	23" or 29"	23" or 29"	211/18.6	\$6,419	\$6,829	
82"	88"	23" or 29"	23" or 29"	216/18.8	\$6,419	\$6,829	
82"	94"	23" or 29"	23" or 29"	220/19.0	\$6,419	\$6,829	
94"	64"	23" or 29"	23" or 29"	207/19.2	\$6,618	\$7,029	
94"	70"	23" or 29"	23" or 29"	211/19.4	\$6,618	\$7,029	
94"	76"	23" or 29"	23" or 29"	216/19.6	\$6,618	\$7,029	
94"	82"	23" or 29"	23" or 29"	220/19.8	\$6,618	\$7,029	
94"	88"	23" or 29"	23" or 29"	224/19.9	\$6,618	\$7,029	
94"	94"	23" or 29"	23" or 29"	225/20.1	\$6,618	\$7,029	



ORDER CODE SAMPLE							
ITEM CODE	A SIDE	WIDTH	DEPTH	B SIDE	LAMINATE	HAND	OPTION
MWEELC	29	70	88	29	M1	ML	GC LMP

- Leg provides 1" of leveling
- Laminate codes - M1: 1" LPL, H1: 1" HPL (top only)
- Two piece worksurface will have a seam as shown

- Available in all standard laminates
- Available in standard metal paint finishes
- For sizes not listed, specify actual (not nominal) size in product code

- For 3" grommet (AG30A), add option code(s) 'GL', 'GC' and/or 'GR', add +\$86 per grommet
- For laminate modesty panel, add option code 'LMP' and +\$386

Viva

Manually Operated Height Adjustable Tables

Standard Features:

- LPL & HPL worksurfaces with overall height adjustability from 24" to 36"
- Top access crank handle & grommets are standard (UTS)
- Handle turns 6 revolutions for each 1" of travel
- C Base two and three leg configurations
- Foot design matches all Viva line products
- No electrical power requirements

Optional Features:

- Left, right and center grommets
- Undermount crank handle position

Basic Dimensions:

C-LEG

- Column: 2.0" x 4.0" [51mm x 102mm]
- Foot: 2.88" x 24" [73.2mm x 609.6mm]
- Foot height: 1.375" [34.9mm]

FRAME

- 1.25" x 1.25" [32 x 32mm] spans full width

Finishes:

BASE

- Powdercoat silver, black & white

WORKSURFACE

- 1" & 1.5" LPL & HPL in all standard BRC laminates

General Product Overview:

Table bases are metal and have a durable scratch resistant, heat cured powder coat paint finish. Metal uprights are of 14 gauge tubing 2" thick by 4" wide. On all tables, inserts are of 14 gauge tubing and incorporate Teflon-like slides for smooth operation and low maintenance. All table bases have a 1" x 3" horizontal modesty bar of 16 gauge steel attached to each leg to assure strength and stability throughout the entire range of motion. Low profile foot is constructed of drawn steel, with waterfall front and back edges. The interior of the foot is double walled with 11 gauge steel supports. These feet have easy to access levelers for ease of installation and balancing.

ANSI Bifma and CGSB (Canadian General Standards Board) tested and qualified. This ensures that BRC products adhere to the highest standards of quality and durability in North America.

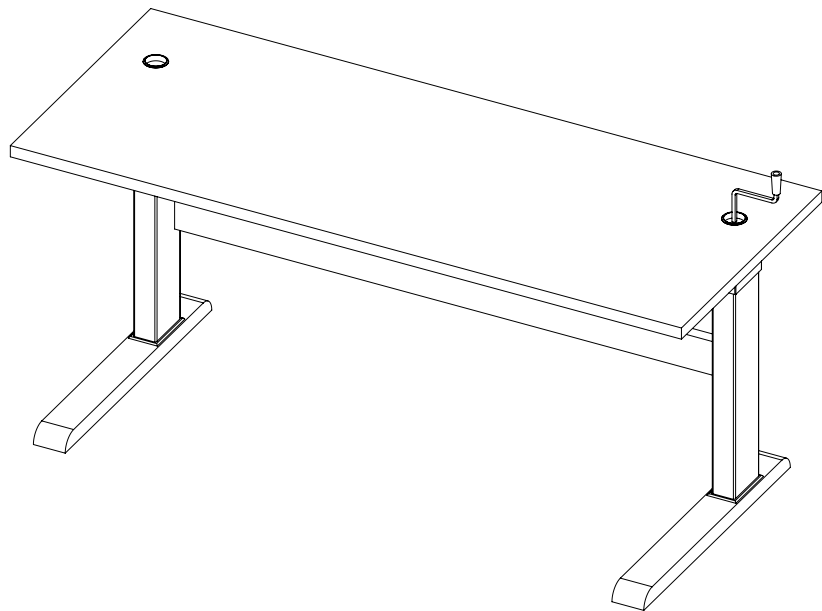

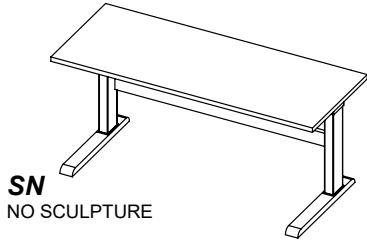

SN
NO SCULPTURE

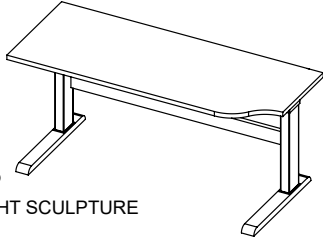

SR
RIGHT SCULPTURE

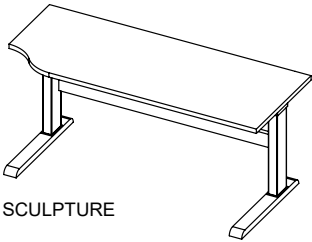

SL
LEFT SCULPTURE

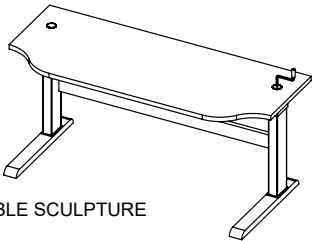

SD
DOUBLE SCULPTURE

Features & Specifications

No Charge Options

Optional Extra

ACTUAL SIZE			LAMINATE	
WIDTH	DEPTH	WEIGHT/CUBE	PRICE M1	PRICE H1
22"	23"	70/30	\$1,676	\$1,787
28"	23"	70/30	\$1,676	\$1,787
34"	23"	80/36	\$1,715	\$1,834
40"	23"	90/48	\$1,750	\$1,879
46"	23"	100/48	\$1,925	\$2,052
52"	23"	105/54	\$1,980	\$2,125
58"	23"	105/60	\$1,980	\$2,125
64"	23"	110/66	\$2,044	\$2,200
70"	23"	115/72	\$2,153	\$2,336
76"	23"	115/72	\$2,453	\$2,648
82"	23"	120/72	\$2,453	\$2,829
28"	29"	75/30	\$1,767	\$1,896
34"	29"	85/36	\$1,816	\$1,944
40"	29"	95/48	\$1,851	\$1,988
46"	29"	105/48	\$2,024	\$2,161
52"	29"	110/60	\$2,125	\$2,316
58"	29"	110/60	\$2,125	\$2,316
64"	29"	110/60	\$2,190	\$2,372
70"	29"	100/72	\$2,243	\$2,444
76"	29"	110/72	\$2,428	\$2,664
82"	29"	120/72	\$2,572	\$2,858
94"	35"	140/75	\$3,122	\$3,423



ORDER CODE SAMPLE					
ITEM CODE	WIDTH	DEPTH	LAMINATE	SCULPTURE	OPTION
MWCC	70	23	H1	SN	LMP

- Leg provides 1" of leveling
- Laminate codes - M1: 1" LPL, H1: 1" HPL (top only)
- Specify sculpture: 'SN' - none, 'SR' - right, 'SL' - left, or 'SD' - double
- Sculpture is 6" deep (eg: 23" depth is 17" at edge when sculptured)
- Top access crank handle/grommets are standard. Undermount option (UTS) does not remove top access holes
- Available in all standard laminates
- Available in standard metal paint finishes
- For sizes not listed, specify actual (not nominal) size in product code
- For 3" grommet (AG30A), add option code(s) 'GL', 'GC' and/or 'GR', add +\$86 per grommet
- For laminate modesty panel, add option code 'LMP' and +\$313
- For under surface handle operation, add option code 'UTS' and +\$268

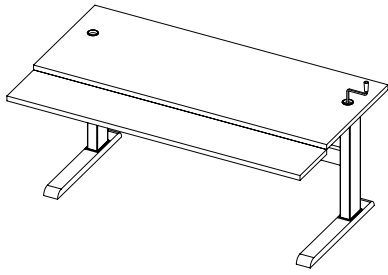

DUAL ARM KEYBOARD

ACTUAL SIZE			LAMINATE	
WIDTH	DEPTH	WEIGHT/CUBE	PRICE M1	PRICE H1
40"	29"	100/60	\$3,202	\$3,480
46"	29"	105/60	\$3,335	\$3,625
58"	29"	115/70	\$3,635	\$3,844
58"	35"	115/70	\$3,705	\$4,028

Features & Specifications

No Charge Options

Optional Extra



ORDER CODE SAMPLE				
ITEM CODE	WIDTH	DEPTH	LAMINATE	OPTION
MTCC	58	29	H1	LMP

- Leg provides 1" of leveling
- Laminate codes - M1: 1" LPL, H1: 1" HPL (top only)
- Default KBKW-27 dual arm keyboard mechanism has a range of 9.5" above and 6.5" below work-surface with 15 degrees positive or negative tilt
- Top access crank handle/grommets are standard. Undermount option (UTS) does not remove top access holes
- Available in all standard laminates
- Available in standard metal paint finishes
- For sizes not listed, specify actual (not nominal) size in product code
- For 3" grommet (AG30A), add option code(s) 'GL', 'GC' and/or 'GR', add +\$86 per grommet
- For laminate modesty panel, add option code 'LMP' and +\$313
- For sliding keyboard with 5" of adjustment; add option code 'KW(FOC)' and +\$474



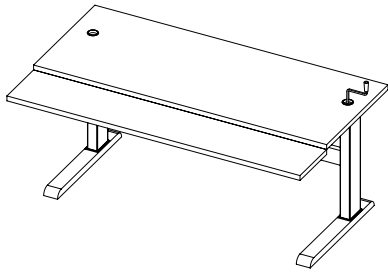

SINGLE ARM KEYBOARD

ACTUAL SIZE			LAMINATE	
WIDTH	DEPTH	WEIGHT/CUBE	PRICE M1	PRICE H1
28"	29"	89/40	\$2,648	\$2,874
45"	29"	95/50	\$2,697	\$2,930

Features & Specifications

No Charge Options

Optional Extra



ORDER CODE SAMPLE				
ITEM CODE	WIDTH	DEPTH	LAMINATE	OPTION
MTCCSA	28	29	H1	LMP

- Leg provides 1" of leveling
- Laminate codes - M1: 1" LPL, H1: 1" HPL (top only)
- Default KBSS single arm keyboard mechanism has a range of 5.8" above and 8.2" below worksurface with 15 degrees positive or negative tilt
- Top access crank handle/grommets are standard. Undermount option (UTS) does not remove top access holes
- Available in all standard laminates
- Available in standard metal paint finishes
- For sizes not listed, specify actual (not nominal) size in product code
- For 3" grommet (AG30A), add option code(s) 'GL', 'GC' and/or 'GR', add +\$86 per grommet
- For laminate modesty panel, add option code 'LMP' and +\$313

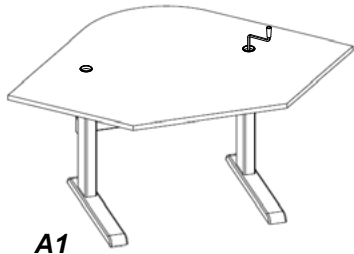

A1
STRAIGHT FRONT
CURVE BACK

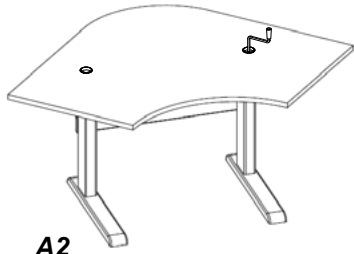

A2
CURVE FRONT
CURVE BACK

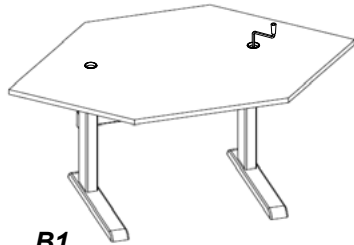

B1
STRAIGHT FRONT
STRAIGHT BACK

ACTUAL SIZE				LAMINATE	
WIDTH	DEPTH	USER WIDTH	WEIGHT/ CUBE	PRICE M1	PRICE H1
28"	23"	9"	90/54	\$1,610	\$1,944
34"	23"	17"	90/54	\$1,610	\$1,944
40"	23"	25"	100/60	\$1,779	\$2,125
46"	23"	34"	105/60	\$2,572	\$2,638
40"	29"	17"	105/60	\$1,779	\$2,125
46"	29"	25"	105/60	\$2,572	\$2,638



ORDER CODE SAMPLE					
ITEM CODE	WIDTH	DEPTH	LAMINATE	STYLE	OPTION
MTKCC	46	29	H1	A1	LMP

Features & Specifications

- Leg provides 1" of leveling
- Laminate codes - M1: 1" LPL, H1: 1" HPL (top only)
- Specify worksurface style: 'A1', 'A2' or 'B1'
- Top access crank handle/grommets are standard. Undermount option (UTS) does not remove top access holes

No Charge Options

- Available in all standard laminates
- Available in standard metal paint finishes
- For sizes not listed, specify actual (not nominal) size in product code

Optional Extra

- For 3" grommet (AG30A), add option code(s) 'GL', 'GC' and/or 'GR', add +\$86 per grommet
- For laminate modesty panel, add option code 'LMP' and +\$313

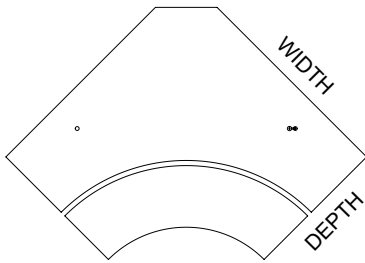
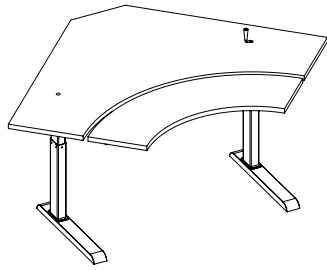

ACTUAL SIZE			LAMINATE	
WIDTH	DEPTH	WEIGHT/CUBE	PRICE M1	PRICE H1
40"	17"	100/60	\$3,622	\$3,938
40"	23"	100/60	\$3,622	\$3,938
46"	23"	105/60	\$3,705	\$4,028
46"	29"	105/60	\$3,705	\$4,028

Features & Specifications

No Charge Options

Optional Extra



ORDER CODE SAMPLE				
ITEM CODE	WIDTH	DEPTH	LAMINATE	OPTION
MTKCCVC	46	29	H1	LMP

- Leg provides 1" of leveling
- Laminate codes - M1: 1" LPL, H1: 1" HPL (top only)
- Default KBKW dual arm keyboard mechanism has a range of 9.5" above and 6.5" below worksurface with 15 degrees positive or negative tilt
- Top access crank handle/grommets are standard. Undermount option (UTS) does not remove top access holes
- Available in all standard laminates
- Available in standard metal paint finishes
- For sizes not listed, specify actual (not nominal) size in product code
- Straight front available; add option *SF* to product code
- For 3" grommet (AG30A), add option code(s) 'GL', 'GC' and/or 'GR', add +\$86 per grommet
- For laminate modesty panel, add option code 'LMP' and +\$313

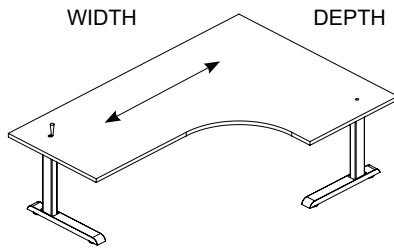

EL
EXTENDED LEFT

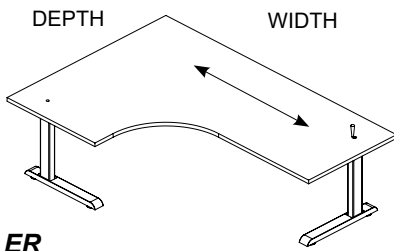

ER
EXTENDED RIGHT

23" DEEP RETURN ON BOTH SIDES

ARROWS INDICATE GRAIN DIRECTION (IF APPLICABLE)

ACTUAL SIZE					LAMINATE	
WIDTH	DEPTH	RETURN	RADIUS	WT/CUBE	PRICE M1	PRICE H1
58"	40"	23"	18"	149/11.0	\$4,083	\$4,494
58"	46"	23"	18"	149/11.0	\$4,083	\$4,494
58"	52"	23"	18"	149/11.0	\$4,164	\$4,573
64"	40"	23"	18"	176/14.6	\$4,121	\$4,534
64"	46"	23"	18"	176/14.6	\$4,121	\$4,534
64"	52"	23"	18"	176/14.6	\$4,193	\$4,604
64"	58"	23"	18"	176/14.6	\$4,254	\$4,665
70"	40"	23"	18"	189/15.9	\$4,121	\$4,534
70"	46"	23"	18"	189/15.9	\$4,121	\$4,534
70"	52"	23"	18"	189/15.9	\$4,193	\$4,604
70"	58"	23"	18"	189/15.9	\$4,373	\$4,784



ORDER CODE SAMPLE							
ITEM CODE	RETURN	WIDTH	DEPTH	RETURN	LAMINATE	STYLE	OPTION
MECCK	23	70	46	23	M1	EL	GC

Features & Specifications

No Charge Options

Optional Extra

- Leg provides 1" of leveling
- Laminate codes - M1: 1" LPL, H1: 1" HPL (top only)
- Woodgrain runs horizontally on the longest side of the table
- Specify style - 'ER' - extended right, or 'EL' - extended left
- Top access crank handle/grommets are standard. Undermount option (UTS) does not remove top access holes
- Available in all standard laminates
- Available in standard metal paint finishes
- For sizes not listed, specify actual (not nominal) size in product code
- For straight front instead of standard curved, add code SF to options
- For 3" grommet (AG30A), add option code(s) 'GL', 'GC' and/or 'GR', add +\$86 per grommet
- For laminate modesty panel, add option code 'LMP' and +\$386
- For under surface handle operation, add option code 'UTS' and +\$268



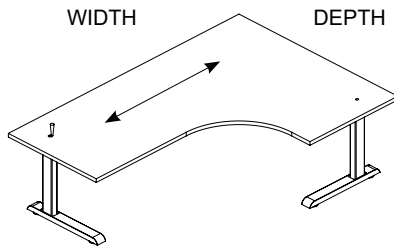

EL
EXTENDED LEFT

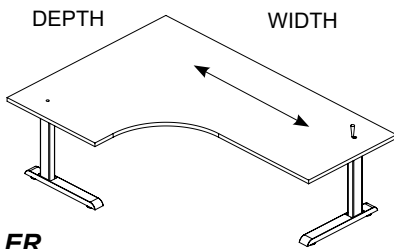

ER
EXTENDED RIGHT

29" DEEP RETURN ON BOTH SIDES

ARROWS INDICATE GRAIN DIRECTION
(IF APPLICABLE)

Features & Specifications

No Charge Options

Optional Extra

ACTUAL SIZE					LAMINATE	
WIDTH	DEPTH	RETURN	RADIUS	WT/CUBE	PRICE M1	PRICE H1
58"	40"	29"	18"	149/11.0	\$4,102	\$4,510
58"	46"	29"	18"	149/11.0	\$4,102	\$4,521
58"	52"	29"	18"	149/11.0	\$4,182	\$4,592
64"	40"	29"	18"	176/14.6	\$4,142	\$4,553
64"	46"	29"	18"	176/14.6	\$4,142	\$4,553
64"	52"	29"	18"	176/14.6	\$4,211	\$4,624
64"	58"	29"	18"	176/14.6	\$4,274	\$4,685
70"	40"	29"	18"	189/15.9	\$4,142	\$4,553
70"	46"	29"	18"	189/15.9	\$4,142	\$4,553
70"	52"	29"	18"	189/15.9	\$4,211	\$4,624
70"	58"	29"	18"	189/15.9	\$4,393	\$4,803



ORDER CODE SAMPLE							
ITEM CODE	RETURN	WIDTH	DEPTH	RETURN	LAMINATE	STYLE	OPTION
MECCK	29	70	46	29	M1	EL	GC

- Leg provides 1" of leveling
- Laminate codes - M1: 1" LPL, H1: 1" HPL (top only)
- Woodgrain runs horizontally on the longest side of the table
- Specify style - 'ER' - extended right, or 'EL' - extended left
- Top access crank handle/grommets are standard. Undermount option (UTS) does not remove top access holes
- Available in all standard laminates
- Available in standard metal paint finishes
- For sizes not listed, specify actual (not nominal) size in product code
- For straight front instead of standard curved, add code SF to options
- For 3" grommet (AG30A), add option code(s) 'GL', 'GC' and/or 'GR', add +\$86 per grommet
- For laminate modesty panel, add option code 'LMP' and +\$386
- For under surface handle operation, add option code 'UTS' and +\$268

PRODUCT MAP

TABLE OF CONTENTS

MESA ELECTRIC

VIVA ELECTRIC

VIVA MANUAL

VIVA INCREMENTAL

VIVA FIXED HEIGHT

SOHO

NOLITA

CONTROLLERS

www.brc.group

Viva

Incremental Height Adjustable Tables

Standard Features:

- LPL & HPL worksurfaces with overall height adjustability from 24" to 36" in one inch increments
- C Base two and three leg configurations
- Foot design matches all Viva line products
- No electrical power requirements

Optional Features:

- Left, right and center grommets

Basic Dimensions:

C-LEG

- Column: 2.0" x 4.0" [51mm x 102mm]
- Foot: 2.88" x 24" [73.2mm x 609.6mm]
- Foot height: 1.375" [34.9mm]

Finishes:

BASE

- Powdercoat silver, black & white

WORKSURFACE

- 1" & 1.5" LPL & HPL in all standard BRC laminates

General Product Overview:

Table bases are metal and have a durable scratch resistant, heat cured powder coat paint finish. Metal uprights are of 14 gauge tubing 2" thick by 4" wide. All table bases have a 1" x 3" horizontal modesty bar of 16 gauge steel attached to each leg to assure strength and stability. Incremental adjustment is made by removing the socket cap bolt on the back of each leg, setting height required and replacing bolt. Low profile foot is constructed of drawn steel, with waterfall front and back edges. The interior of the foot is double walled with 11 gauge steel supports. These feet have easy to access levelers for ease of installation and balancing.

ANSI Bifma and CGSB (Canadian General Standards Board) tested and qualified. This ensures that BRC products adhere to the highest standards of quality and durability in North America.

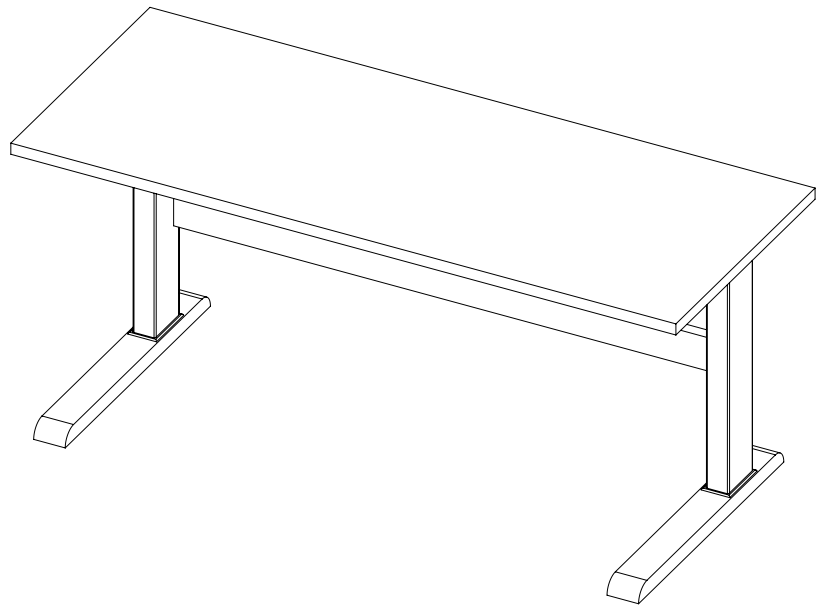

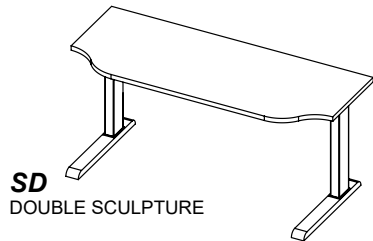
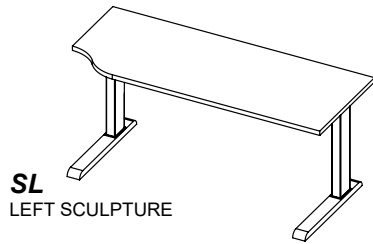
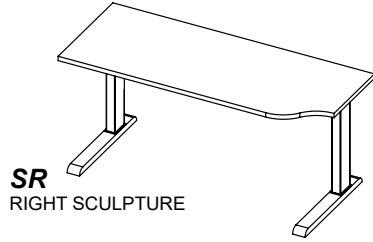
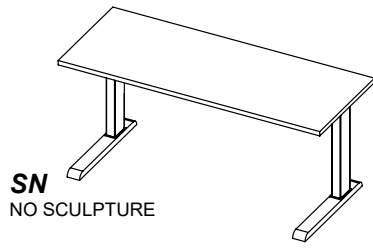

ACTUAL SIZE			LAMINATE	
WIDTH	DEPTH	WEIGHT/CUBE	PRICE M1	PRICE H1
22"	23"	70/30	\$1,313	\$1,424
28"	23"	70/30	\$1,313	\$1,424
34"	23"	70/30	\$1,346	\$1,465
40"	23"	80/36	\$1,384	\$1,511
46"	23"	90/48	\$1,559	\$1,684
58"	23"	100/48	\$1,610	\$1,760
64"	23"	105/60	\$1,696	\$1,877
70"	23"	115/72	\$1,787	\$1,972
76"	23"	115/72	\$2,060	\$2,300
82"	23"	120/76	\$2,206	\$2,491
28"	29"	75/30	\$1,402	\$1,532
34"	29"	85/36	\$1,449	\$1,575
40"	29"	95/48	\$1,487	\$1,621
46"	29"	105/48	\$1,658	\$1,795
58"	29"	110/60	\$1,760	\$1,949
64"	29"	110/60	\$1,827	\$2,026
70"	29"	110/72	\$1,879	\$2,081
76"	29"	110/72	\$2,060	\$2,300
82"	29"	120/72	\$2,206	\$2,491
82"	35"	120/72	\$2,337	\$2,625
94"	35"	140/75	\$2,757	\$3,055



ORDER CODE SAMPLE					
ITEM CODE	WIDTH	DEPTH	LAMINATE	SCULPTURE	OPTION
MTCI	70	23	H1	SN	LMP BF

Features & Specifications

No Charge Options

Optional Extra

- Leg provides 1" of leveling
- Laminate codes - M1: 1" LPL, H1: 1" HPL (top only)
- Specify sculpture - 'SN' - none, 'SR' - right, 'SL' - left, or 'SD' - double

- Available in all standard laminates
- Available in standard metal paint finishes
- For sizes not listed, specify actual (not nominal) size in product code

- For 3" grommet (AG30A), add option code(s) 'GL', 'GC' and/or 'GR', add +\$86 per grommet
- For laminate modesty panel, add option code 'LMP' and +\$313
- For 6" Bow fronts on tables 58" and larger; add option code 'BF' and +\$242

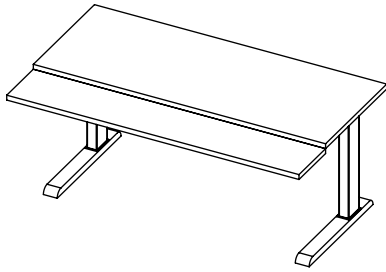

DUAL ARM KEYBOARD

ACTUAL SIZE			LAMINATE	
WIDTH	DEPTH	WEIGHT/CUBE	PRICE M1	PRICE H1
40"	29"	100/6	\$2,700	\$2,965
46"	29"	115/6	\$2,829	\$3,105
58"	29"	125/7	\$3,003	\$3,487
70"	29"	135/8	\$3,357	\$3,661



ORDER CODE SAMPLE			
ITEM CODE	WIDTH	LAMINATE	OPTION
MTCI	58	H1	LMP

Features & Specifications

- Leg provides 1" of leveling
- Laminate codes - M1: 1" LPL, H1: 1" HPL (top only)
- Default KBKW-B dual arm keyboard mechanism has a range of 9.5" above and 6.5" below worksurface with 15 degrees positive or negative tilt

No Charge Options

- Available in all standard laminates
- Available in standard metal paint finishes
- For sizes not listed, specify actual (not nominal) size in product code

Optional Extra

- For 3" grommet (AG30A), add option code(s) 'GL', 'GC' and/or 'GR', add +\$86 per grommet
- For laminate modesty panel, add option code 'LMP' and +\$313
- For sliding keyboard with 5" of adjustment; add option code 'KW(FOC)' and +\$474

Viva Incremental Dual Surface, Single Arm Table

MTCISA

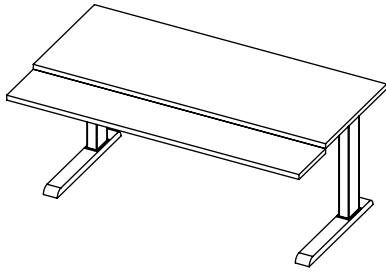

SINGLE ARM KEYBOARD

ACTUAL SIZE			LAMINATE	
WIDTH	DEPTH	WEIGHT/CUBE	PRICE M1	PRICE H1
28"	29"	89/40	\$2,171	\$2,391
34"	29"	95/50	\$2,220	\$2,442



ORDER CODE SAMPLE			
ITEM CODE	WIDTH	LAMINATE	OPTION
MTCISA	34	H1	LMP

Features & Specifications

- Leg provides 1" of leveling
- Laminate codes - M1: 1" LPL, H1: 1" HPL (top only)
- Default KBSS single arm keyboard mechanism has a range of 6" above and 6" below worksurface with 15 degrees positive or negative tilt

No Charge Options

- Available in all standard laminates
- Available in standard metal paint finishes
- For sizes not listed, specify actual (not nominal) size in product code

Optional Extra

- For 3" grommet (AG30A), add option code(s) 'GL', 'GC' and/or 'GR', add +\$86 per grommet
- For laminate modesty panel, add option code 'LMP' and +\$313



Viva

Fixed Height Tables

Standard Features:

- Fixed height base at 29" height overall with 1" worksurface (29.5" with 1.5" worksurface)
- LPL & HPL worksurfaces
- C Base with two and three leg configurations
- Foot provides 1" of levelling

Optional Features:

- Available with casters
- Left, right and center grommets

Basic Dimensions:

C-LEG

- Column: 2.0" x 4.0" [51mm x 102mm]
- Foot: 2.88" x 24" [73.2mm x 609.6mm]
- Foot height: 1.375" [34.9mm]

Finishes:

BASE

- Powdercoat silver, black & white

WORKSURFACE

- 1" & 1.5" LPL & HPL in all standard BRC laminates

General Product Overview:

Table bases are metal and have a durable scratch resistant, heat cured powder coat paint finish. Table surfaces are supported by a 3/4" x 1 1/2" steel frame designed for strength and ease of connections. Metal uprights are of 14 gauge tubing 2" thick by 4" wide. On all tables, inserts are of 14 gauge tubing and incorporate Teflon-like slides for smooth operation and low maintenance. All table bases have a 1" x 3" horizontal modesty bar of 16 gauge steel attached to each leg to assure strength and stability throughout the entire range of motion. Low profile foot is constructed of drawn steel, with waterfall front and back edges. The interior of the foot is double walled with 11 gauge steel supports. These feet have easy to access levelers for ease of installation and balancing.

ANSI Bifma and CGSB (Canadian General Standards Board) tested and qualified. This ensures that BRC products adhere to the highest standards of quality and durability in North America.

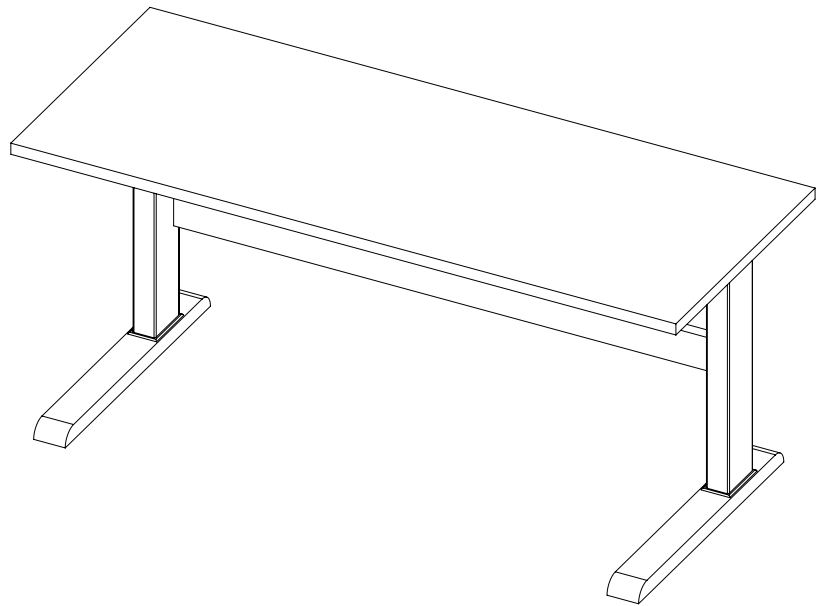

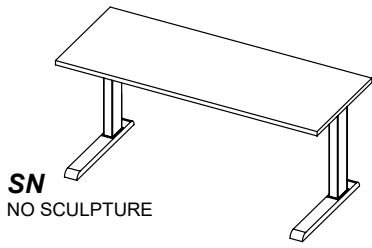

SN
NO SCULPTURE

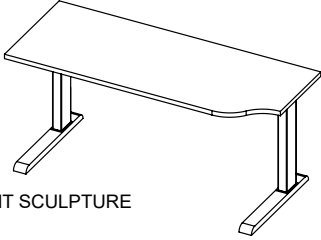

SR
RIGHT SCULPTURE

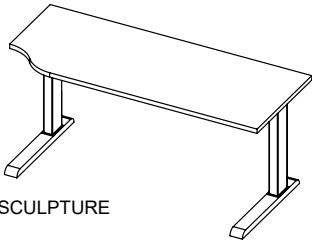

SL
LEFT SCULPTURE

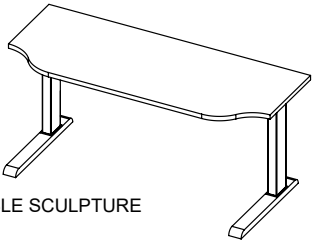

SD
DOUBLE SCULPTURE

Features & Specifications

No Charge Options

Optional Extra

ACTUAL SIZE			LAMINATE	
WIDTH	DEPTH	WEIGHT/CUBE	PRICE M1	PRICE H1
22"	23"	70/30	\$1,127	\$1,237
28"	23"	70/30	\$1,127	\$1,237
34"	23"	70/30	\$1,164	\$1,283
40"	23"	80/36	\$1,203	\$1,329
46"	23"	90/48	\$1,376	\$1,502
52"	23"	90/48	\$1,429	\$1,575
58"	23"	100/48	\$1,429	\$1,575
64"	23"	105/60	\$1,496	\$1,649
70"	23"	115/72	\$1,605	\$1,787
76"	23"	115/72	\$1,907	\$2,097
82"	23"	120/76	\$1,907	\$2,280
28"	29"	75/30	\$1,219	\$1,346
34"	29"	85/36	\$1,267	\$1,394
40"	29"	95/48	\$1,302	\$1,438
46"	29"	105/48	\$1,474	\$1,610
52"	29"	105/48	\$1,575	\$1,767
58"	29"	110/60	\$1,575	\$1,767
64"	29"	110/60	\$1,641	\$1,824
70"	29"	110/72	\$1,697	\$1,896
76"	29"	110/72	\$1,879	\$2,117
82"	29"	120/72	\$2,024	\$2,310
94"	35"	140/75	\$2,391	\$2,872



ORDER CODE SAMPLE					
ITEM CODE	WIDTH	DEPTH	LAMINATE	SCULPTURE	OPTION
MWCF	70	23	M1	SD	LMP BF

- Leg provides 1" of leveling
- Laminate codes - M1: 1" LPL, H1: 1" HPL (top only)
- Specify sculpture - 'SN' - none, 'SR' - right, 'SL' - left, or 'SD' - double

- Available in all standard laminates
- Available in standard metal paint finishes
- For sizes not listed, specify actual (not nominal) size in product code

- For 3" grommet (AG30A), add option code(s) 'GL', 'GC' and/or 'GR', add +\$86 per grommet
- For laminate modesty panel, add option code 'LMP' and +\$313
- For 6" Bow fronts on tables 58" and larger; add option code 'BF' and +\$242



A1
STRAIGHT FRONT
CURVE BACK

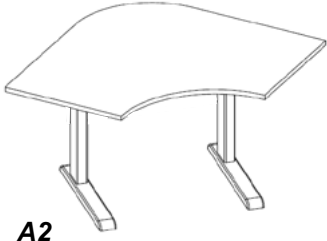

A2
CURVE FRONT
CURVE BACK



B1
STRAIGHT FRONT
STRAIGHT BACK

ACTUAL SIZE				LAMINATE	
WIDTH	DEPTH	USER WIDTH	WEIGHT/ CUBE	PRICE M1	PRICE H1
28"	23"	9"	90/54	\$1,248	\$1,394
34"	23"	17"	90/54	\$1,248	\$1,394
40"	23"	25"	100/60	\$1,841	\$2,014
46"	23"	34"	105/60	\$2,024	\$2,088
40"	29"	17"	105/60	\$1,841	\$2,014
46"	29"	25"	105/60	\$2,024	\$2,088

Features & Specifications

No Charge Options

Optional Extra



ORDER CODE SAMPLE					
ITEM CODE	WIDTH	DEPTH	LAMINATE	STYLE	OPTION
MTKCF	46	29	H1	A1	LMP

- Leg provides 1" of leveling
- Laminate codes - M1: 1" LPL, H1: 1" HPL (top only)
- Specify worksurface style: 'A1', 'A2' or 'B1'

- Available in all standard laminates
- Available in standard metal paint finishes
- For sizes not listed, specify actual (not nominal) size in product code

- For 3" grommet (AG30A), add option code(s) 'GL', 'GC' and/or 'GR', add +\$86 per grommet
- For laminate modesty panel, add option code 'LMP' and +\$313

SoHo

Executive Electric Height Adjustability with Storage

Standard Features:

- Raised dual one box, one file (BF) locking pedestals
- Anti collision piezoelectric sensor stops movement when obstruction is encountered
- Dual motors use 0.1W standby and are whisper quiet at 55db when in use. 125" Cord length
- LPL & HPL worksurfaces
- Floating half modesty panel
- Height range from 27" to 50"
- 300lb lift capacity with 1.5" per second travel
- Premium handset (DPG1C) included
- Bluetooth with Desk Control App

Optional Features:

- Left, right and center grommets
- Rechargeable Battery

Basic Dimensions:

BOX FILE PEDESTAL

- 4" high post feet with 1" leveling
- 15.75" wide x 23.375" high x variable depths

Finishes:

COLUMN & POST FEET

- Powdercoat silver, black & white

WORKSURFACE

- 1" LPL & HPL in all standard BRC laminates
- 1.25" HPL knife edge

General Product Overview:

Table base frames are metal and have a durable scratch resistant, heat cured powder coat paint finish. Table surfaces are supported by a 3/4" x 1 1/2" steel frame designed for strength and ease of connections. Metal uprights are of 14 gauge tubing 2" thick by 4" wide. On all tables, inserts are of 14 gauge tubing and incorporate Teflon-like slides for smooth operation and low maintenance. One box, one file pedestals are locking and raised on 4" post feet with 1" leveling capability. All standard BRC laminates, handles and metal colours are available. Worksurface width and depth are overall dimensions; pedestals do not protrude past this.

ANSI Bifma and CGSB (Canadian General Standards Board) tested and qualified. This ensures that BRC products adhere to the highest standards of quality and durability in North America.

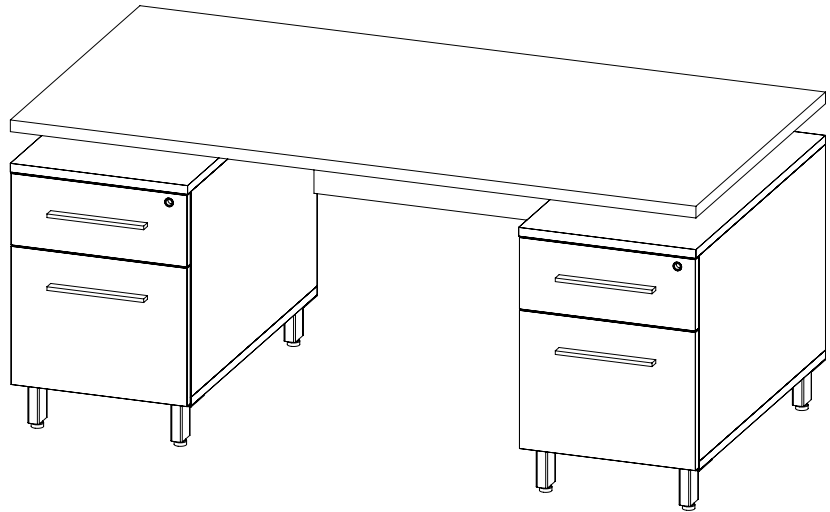

SoHo Executive Electric Table with Storage

SOHO

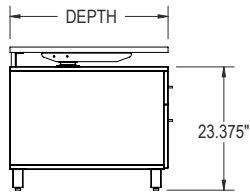
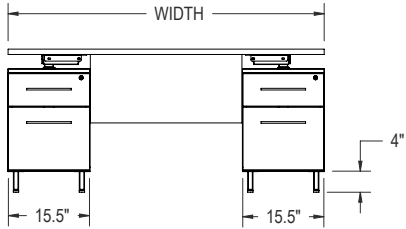
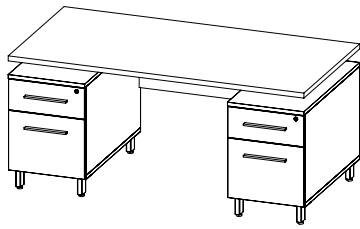

ACTUAL SIZE		LAMINATE		
WIDTH	DEPTH	PRICE M1	PRICE H1	PRICE K1
60"	30"	\$5,463	\$5,928	\$7,046
66"	30"	\$5,525	\$5,983	\$7,177
72"	30"	\$5,575	\$6,056	\$7,326
78"	30"	\$5,749	\$6,274	\$7,620
84"	30"	\$5,888	\$6,468	\$7,886
60"	36"	\$5,779	\$6,257	\$7,454
66"	36"	\$5,840	\$6,314	\$7,586
72"	36"	\$5,890	\$6,389	\$7,732
78"	36"	\$6,065	\$6,607	\$8,025
84"	36"	\$6,206	\$6,799	\$8,295

Features & Specifications

No Charge Options

Optional Extra



ORDER CODE SAMPLE				
ITEM CODE	WIDTH	DEPTH	LAMINATE	OPTION
SOHO	72	30	H1	HP

- Leg provides 1" of leveling
- Laminate codes - M1: 1" LPL, H1: 1" HPL, K1: 1" HPL knife edge (top only)
- Includes floating laminate modesty panel
- Dual box file pedestals are keyed alike by default

- Available in all standard laminates
- Frame available in standard metal paint finishes

- For 3" grommet (AG30A), add option code(s) 'GL', 'GC' and/or 'GR', add +\$86 per grommet
- For high pressure drawer fronts, add option code 'HP' and +\$370

NoLita

Dynamic Electric Height Adjustability

Standard Features:

- LPL & HPL Worksurfaces available with overall height adjustability from 25.75" to 46.25"
- Anti collision sensor stops movement when obstruction is encountered
- 0.75" Gap between worksurfaces to allow for pinch clearance
- Dual motors use 0.1W standby and are whisper quiet at 55db when in use
- LPL, HPL and knife edge worksurfaces
- Concealed frosted acrylic modesty panel
- 250lb lift capacity
- Premium handset (DPG1C) included
- Bluetooth with Desk Control App

Optional Features:

- Rechargeable Battery for cordless operation
- Left, right and center grommets

Finishes:

LIFTING COLUMN, TRIM & FRAME

- Powdercoat silver, black or white

WORKSURFACE & FASCIA COVER BASE

- 1" LPL & HPL in all standard BRC laminates
- 1.25" HPL knife edge on three sides; flat edge on back side

Trim:

- Optional knife edge trim does not cover entire perimeter; see graphic below for details

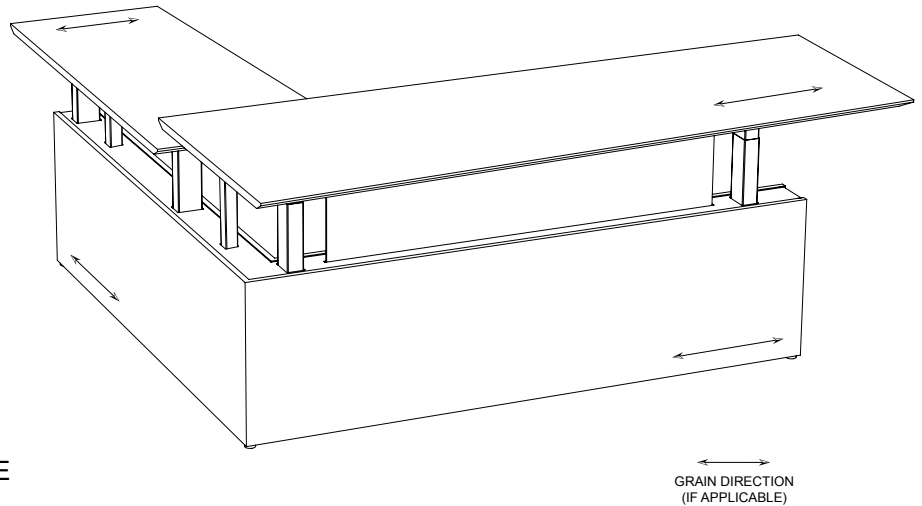
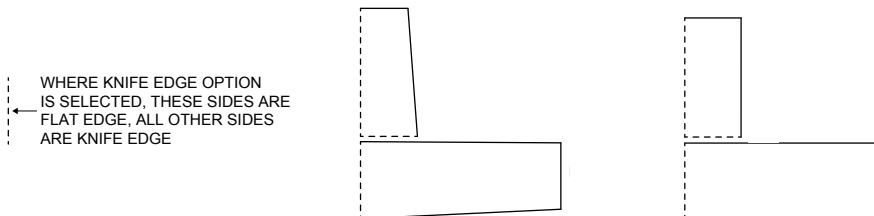

General Product Overview:

Lower cover fascia is made from LP laminate available in all BRC standard finishes. Lower cover fascia end and top trim caps are metal and painted to match the lifting columns. Table base internal frames are metal and have a durable scratch resistant, heat cured powder coat paint finish. Table surfaces are supported by a 1 1/4" tubular steel frame designed for strength and ease of connections. One or both surfaces are available to be height adjustable. The concealed modesty panel is available as standard on one surface only. Due to the nature of this product, extended lead times may apply. Please contact orders@brc.group for details before ordering.

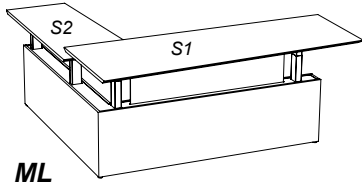

ML
MAIN LEFT

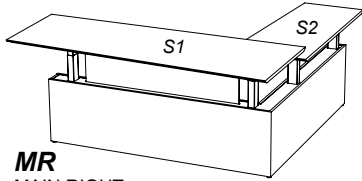

MR
MAIN RIGHT

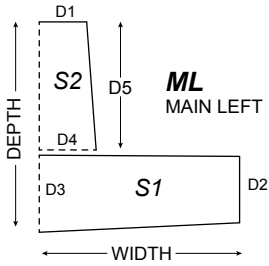
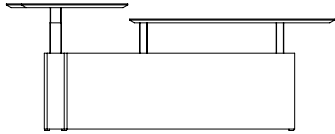

WHERE KNIFE EDGE OPTION IS SELECTED, THESE SIDES ARE FLAT EDGE, ALL OTHER SIDES ARE KNIFE EDGE

Features & Specifications

No Charge Options

Optional Extra

OVERALL SIZE		LAMINATE		
WIDTH	DEPTH	PRICE M1	PRICE H1	PRICE K1
63"	72"	\$16,528	\$16,927	\$18,524
66"	72"	\$16,572	\$17,129	\$18,978
72"	72"	\$16,889	\$17,515	\$19,310
63"	78"	\$16,996	\$17,626	\$19,348
66"	78"	\$17,028	\$17,655	\$19,387
72"	78"	\$17,078	\$17,705	\$19,417
63"	81"	\$17,108	\$17,735	\$19,449
66"	81"	\$17,138	\$17,765	\$19,478
72"	81"	\$17,369	\$18,047	\$19,766

Product Description:

- Dual surface means both worksurfaces are independently height adjustable.
- Two handset controllers are provided for the dual surface NoLita. Note, one controller cannot be used to control both surfaces at the same time.
- Worksurface is tapered as shown.

DIMENSION CHART						
WIDTH	DEPTH	D1	D2	D3	D4	D5
72"	81"	26"	28"	32"	30"	48.25"
66"	81"	26"	28"	32"	30"	48.25"
63"	81"	26"	28"	32"	30"	48.25"
72"	78"	26"	28"	32"	30"	45.25"
66"	78"	26"	28"	32"	30"	45.25"
63"	78"	26"	28"	32"	30"	45.25"
72"	72"	26"	28"	32"	30"	39.25"
66"	72"	26"	28"	32"	30"	39.25"
63"	72"	26"	28"	32"	30"	39.25"



ORDER CODE SAMPLE						
ITEM CODE	WIDTH	DEPTH	LAMINATE	HAND	GROMMET	BASE
NLTADT	72	78	K1	ML	S1GC	HPB

- Base provides 1" of leveling
- Laminate codes - M1: 1" LPL, H1: 1" HPL, K1: 1" HPL knife edge (top only)
- Both surfaces provide separate height adjustability
- Includes frosted acrylic concealed modesty panel on right hand (S1) worksurface only
- Controller placement can be determined on site

- Available in all standard laminates
- Frame available in standard metal paint finishes

- For grommets, specify surface first ('S1' or 'S2') and then option code 'GL' (left), 'GC' (center) and/or 'GR' (right) and +\$86 per grommet
- Base cover available in HPL (LPL by default). Add option code 'HPB' and +\$2,054

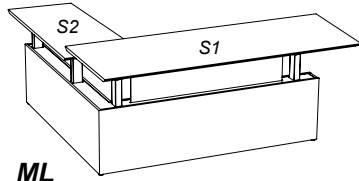

ML
MAIN LEFT

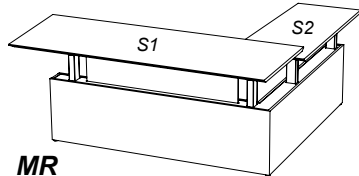

MR
MAIN RIGHT

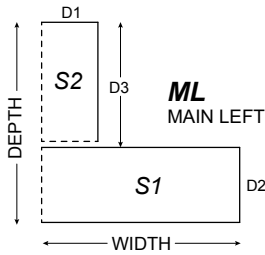
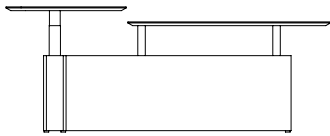

WHERE KNIFE EDGE OPTION IS SELECTED, THESE SIDES ARE FLAT EDGE. ALL OTHER SIDES ARE KNIFE EDGE

Features & Specifications

No Charge Options

Optional Extra

OVERALL SIZE		LAMINATE		
WIDTH	DEPTH	PRICE M1	PRICE H1	PRICE K1
63"	72"	\$16,528	\$16,927	\$18,524
66"	72"	\$16,572	\$17,129	\$18,978
72"	72"	\$16,889	\$17,515	\$19,310
63"	78"	\$16,996	\$17,626	\$19,348
66"	78"	\$17,028	\$17,655	\$19,387
72"	78"	\$17,078	\$17,705	\$19,417
63"	81"	\$17,108	\$17,735	\$19,449
66"	81"	\$17,138	\$17,765	\$19,478
72"	81"	\$17,369	\$18,047	\$19,766

Product Description:

- Dual surface means both worksurfaces are independantly height adjustable.
- Two handset controllers are provided for the dual surface NoLita. Note, one controller cannot be used to control both surfaces at the same time.
- Worksurface is rectangular as shown.

DIMENSION CHART				
WIDTH	DEPTH	D1	D2	D3
72"	81"	28"	32"	48.5"
66"	81"	28"	32"	48.5"
63"	81"	28"	32"	48.5"
72"	78"	28"	32"	45.5"
66"	78"	28"	32"	45.5"
63"	78"	28"	32"	45.5"
72"	72"	28"	32"	39.5"
66"	72"	28"	32"	39.5"
63"	72"	28"	32"	39.5"



ORDER CODE SAMPLE						
ITEM CODE	WIDTH	DEPTH	LAMINATE	HAND	GROMMET	BASE
NLTADR	72	78	K1	ML	S1GC	HPB

- Base provides 1" of leveling
- Laminate codes - M1: 1" LPL, H1: 1" HPL, K1: 1" HPL knife edge (top only)
- Both surfaces provide separate height adjustability
- Includes frosted acrylic concealed modesty panel on right hand (S1) worksurface only
- Controller placement can be determined on site

- Available in all standard laminates
- Frame available in standard metal paint finishes

- For grommets, specify surface first ('S1' or 'S2') and then option code 'GL' (left), 'GC' (center) and/ or 'GR' (right) and +\$86 per grommet
- Base cover available in HPL (LPL by default). Add option code 'HPB' and +\$2,054

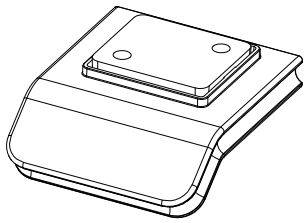

BASIC CONTROLLER

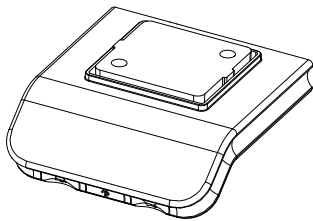

CONTROLLER WITH BLUETOOTH

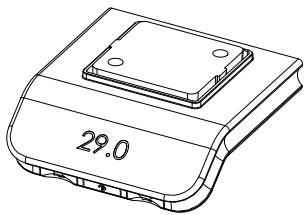

CONTROLLER WITH BLUETOOTH AND DIGITAL DISPLAY

DPG1K	
FEATURES & SPECIFICATIONS	PRICE
<ul style="list-style-type: none"> • Standard on all viva electric height adjustable tables (not available for Mesa) • Lift up to raise, push down to lower 	\$91

DPG1B	
FEATURES & SPECIFICATIONS	PRICE
<ul style="list-style-type: none"> • Lift up to raise, push down to lower • 2 Memory positions • LED light strip reminder • Bluetooth via desk control app • Optional on all Viva electric height adjustable tables (not available for Mesa) • Replaces standard controller DPG1K 	\$222

DPG1C	
FEATURES & SPECIFICATIONS	PRICE
<ul style="list-style-type: none"> • Lift up to raise, push down to lower • 4 Memory positions • LED light strip reminder • Digital height display in metric or imperial units • Bluetooth via desk control app • Standard on all SoHo and NoLita electric height adjustable tables, optional on all Viva tables (not available for Mesa) • Replaces standard controller DPG1K 	\$337



ORDER CODE SAMPLE	
ITEM CODE	CONTROLLER
MWEE7123M1NS	DPG1B

Product Notes

All Viva electric tables ship standard with controller DPG1K. SoHo and NoLita electric tables ship standard with DPG1C. To specify an optional controller, add the model number (eg: DPG1B) to the end of the Viva product code.

These controllers are not available for Mesa electric tables.

Contact BRC for a link to download the desk control app for iOS and Android.

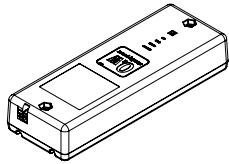

**RECHARGEABLE BATTERY
FOR VIVA, SOHO & NOLITA**

BA001	
FEATURES & SPECIFICATIONS	PRICE
<ul style="list-style-type: none"> • For use with Viva, SoHo and NoLita product only; not for use with Mesa • High performance 2.2 Ah lithium-ion battery • Typically achieves 50-100 full stroke up and down cycles • Features LED light bar indicating capacity • Audible alarm when charging is required • Can be charged with existing table power cord or included external charging cable • Colour: black only • Includes mounting bracket, connecting cable & external charging cable 	<p>\$1,685</p>



ORDER CODE SAMPLE
ITEM CODE
BA001

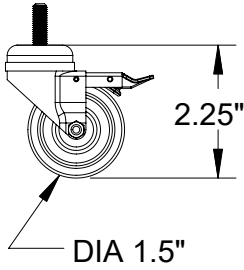
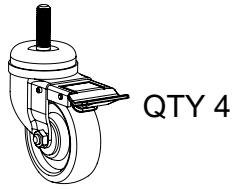

MJCMA	
FEATURES & SPECIFICATIONS	PRICE
<ul style="list-style-type: none"> • Kit includes set of 4 locking casters • Black steel body with hard rubber black wheel • For retrofit on Mesa 2 leg T and C base height adjustable tables • For installtion, remove existing levelers and replace each with locking caster 	\$276 / Set of 4



ORDER CODE SAMPLE
ITEM CODE
MJCMA



MJCDA	
FEATURES & SPECIFICATIONS	PRICE
<ul style="list-style-type: none"> • Kit includes set of 4 locking casters • For retrofit on Mesa 2 leg T and C base height adjustable tables • For installtion, remove existing levelers and replace each with locking caster 	\$276 / Set of 4



ORDER CODE SAMPLE
ITEM CODE
MJCDA

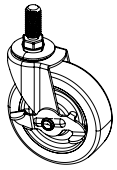

QTY 4

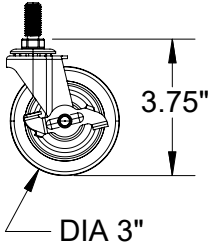

MJCVA	
FEATURES & SPECIFICATIONS	PRICE
<ul style="list-style-type: none"> • Kit includes set of 4 locking casters • Black steel body with hard rubber black wheel • For retrofit on all Viva 2 leg height adjustable tables • For installtion, remove existing levelers and replace each with locking caster 	\$276 / Set of 4



ORDER CODE SAMPLE
ITEM CODE
MJCVA



SWIVEL SKATE CASTER



SWIVEL SKATE CASTER WITH BRAKE



PLATE SKATE CASTER



PLATE SKATE CASTER WITH BRAKE

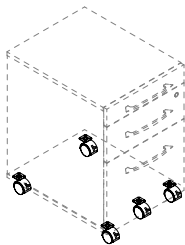

SKATE CASTER REPLACEMENT KIT

ASKCN	
FEATURES & SPECIFICATIONS	PRICE
<ul style="list-style-type: none"> • Caster 2" Dia 3/8-16 x 1" Swivel ICE No Brake • Use with Viva 2 Leg height adjustable tables • 2" Dia Caster no brake • Clear caster 	\$66 each

ASKCB	
FEATURES & SPECIFICATIONS	PRICE
<ul style="list-style-type: none"> • Caster 2" Dia 3/8-16 x 1" Swivel ICE With Brake • Use with Viva 2 Leg height adjustable tables • 2" Dia Caster with brake • Clear caster 	\$66 each

ASKPN	
FEATURES & SPECIFICATIONS	PRICE
<ul style="list-style-type: none"> • Caster 2" Dia Swivel ICE A17D Plate No brake • Plate Caster No Brake • 2" Dia Caster overall height 2-5/8" • Clear caster 	\$66 each

ASKCN	
FEATURES & SPECIFICATIONS	PRICE
<ul style="list-style-type: none"> • Caster 2" Dia Swivel ICE A17D Plate With brake • Plate Caster With Brake • 2" Dia Caster overall height 2-5/8" • Clear caster 	\$66 each

ASKKA	
FEATURES & SPECIFICATIONS	PRICE
<ul style="list-style-type: none"> • Intended for replacement of brc mobile ped casters • Includes 2 locking, 2 non locking and 1 thread stem • Clear caster 	\$207 per kit

▽
ORDER CODE SAMPLE
ITEM CODE
ASKKA

Height Adjustable Table Support Brackets

Height adjustable tables present unique challenges when mounting to adjacent furniture. BRC's table support brackets allow direct connection to Gallery Panels, tall storage, credenzas and other items while allowing full height adjustable functionality. These brackets have been designed specifically for our Mesa T leg and C leg bases but may be applicable to non-BRC product. Contact a BRC representative for full details.

T Leg Rear Mount Bracket

Product Code: MABRA

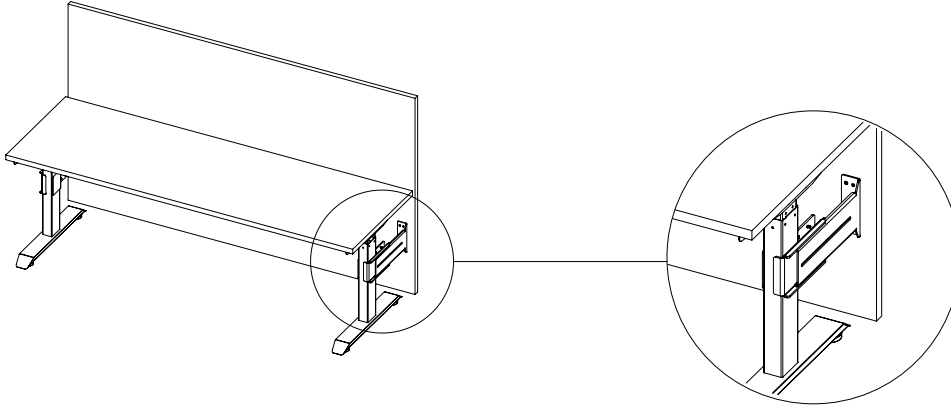

For use on Mesa T leg tables 24", 30" and 36" deep. Connection to rear panel or similar is permanent by way of screws or bolts. Connection to T leg is a clamping mechanism that does not damage or alter the base.

C Leg Rear Mount Bracket

Product Code: MABCA

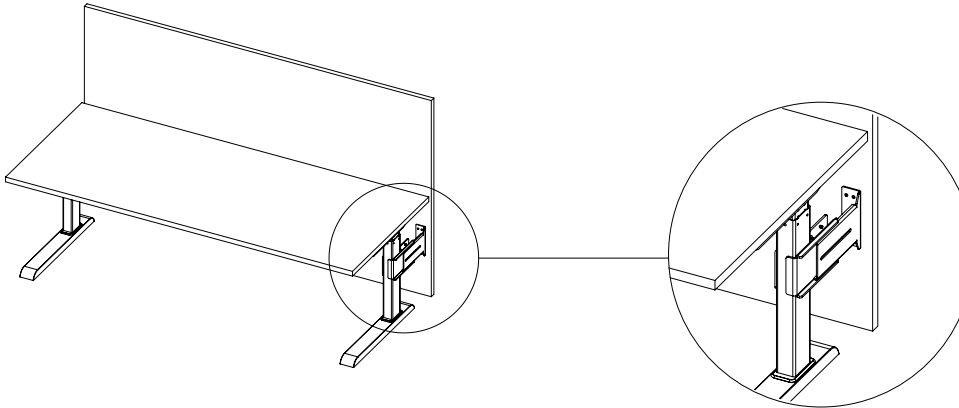

For use on Mesa C leg tables 24", 30" and 36" deep. Connection to rear panel or similar is permanent by way of screws or bolts. Connection to T leg is a clamping mechanism that does not damage or alter the base.

C Leg or T Leg Side Mount Bracket

Product Code: MABSA

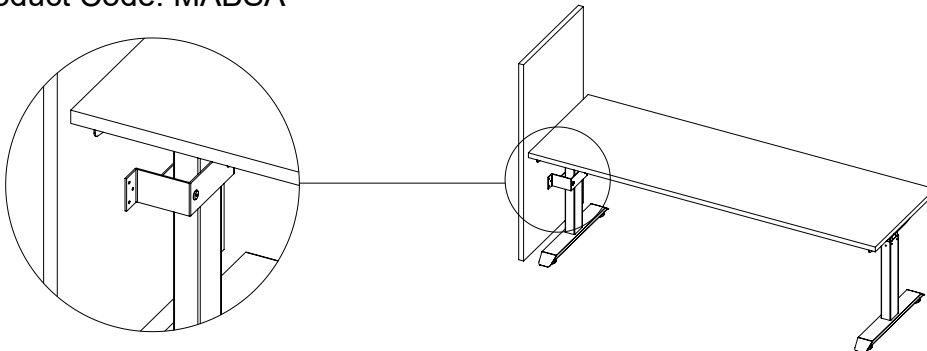

For use on Mesa C leg or T leg tables 24" and 30" deep. Connection to side panel or similar is permanent by way of screws or bolts. Connection to T leg is a clamping mechanism that does not damage or alter the base.

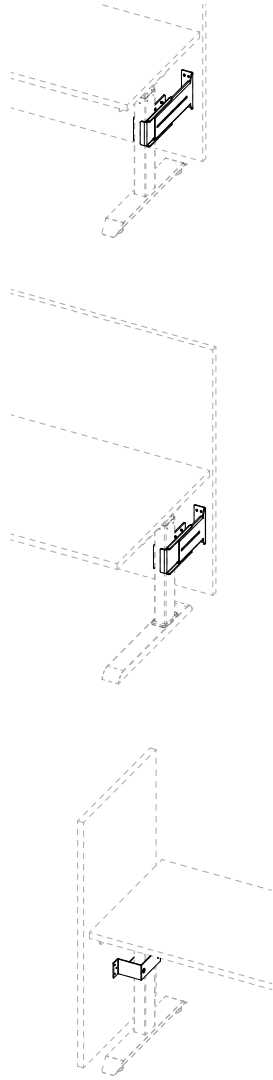

Features & Specifications

MABRA	
FEATURES & SPECIFICATIONS	PRICE
<ul style="list-style-type: none"> • For application to the rear of a height adjustable T leg table • Works with BRC Mesa Table 	\$259

MABCA	
FEATURES & SPECIFICATIONS	PRICE
<ul style="list-style-type: none"> • For application to the rear of a height adjustable C leg table • Works with BRC Mesa Table 	\$259

MABSA	
FEATURES & SPECIFICATIONS	PRICE
<ul style="list-style-type: none"> • For application to the side of a height adjustable table • Works with BRC Mesa T leg and C leg tables 	\$181



ORDER CODE SAMPLE
ITEM CODE
MABRA

- Available in all standard metal finishes
- Includes all hardware to attach to Mesa height adjustable base
- May be compatible with other height adjustable base tables; contact BRC customer service for further details

HAT Accessories

Electrics and Power Modules

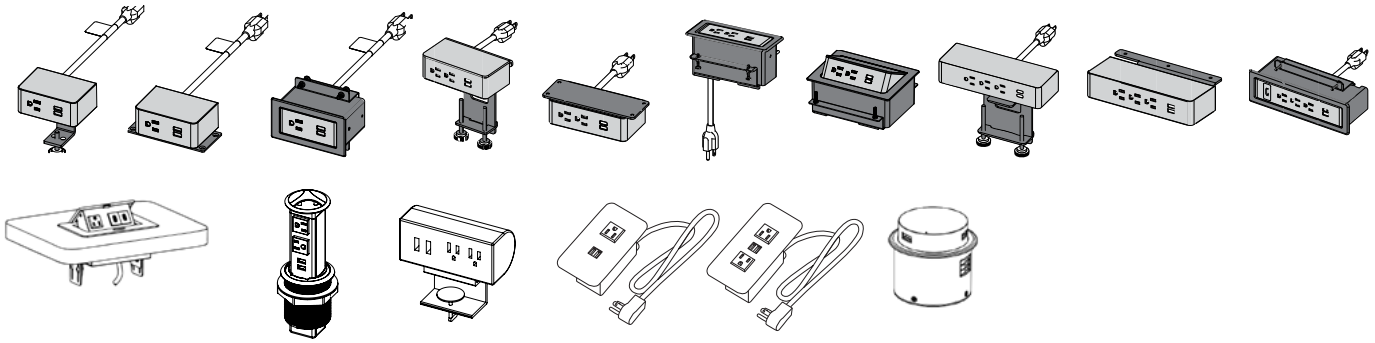

Under Desk Storage



Grommets

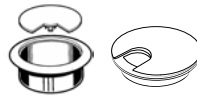

CPU Holders

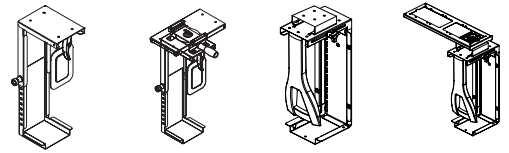

Keyboard Combos

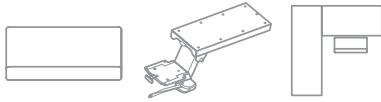

Keyboard Platforms



Keyboard Mechanisms, Corner and Spacers

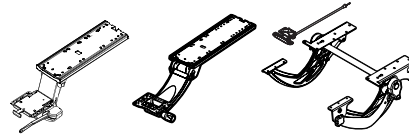

Monitor Arms

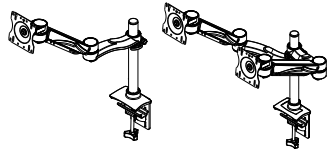

Single Power, Dual USB

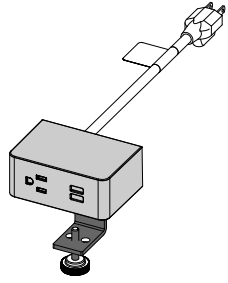

UNO CLAMP ON

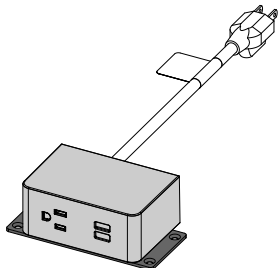

UNO UNDERMOUNT

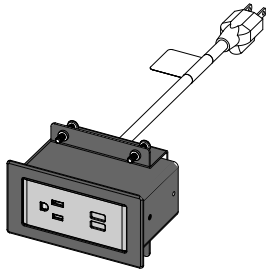

UNO FLUSH MOUNT

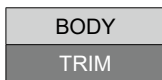

AC1AE	
FEATURES & SPECIFICATIONS	PRICE
<ul style="list-style-type: none"> • Single outlet • Two USB ports • 72" Black corded plug • Finish options: Trim: black, silver or white Body: white, grey, black, orange, red, green, blue 	\$650

AU1AE	
FEATURES & SPECIFICATIONS	PRICE
<ul style="list-style-type: none"> • Single outlet • Two USB ports • 72" Black corded plug • Finish options: Trim: black, silver or white Body: white, grey, black, orange, red, green, blue 	\$614

AF1AE	
FEATURES & SPECIFICATIONS	PRICE
<ul style="list-style-type: none"> • Single outlet • Two USB ports • 72" Black corded plug • Finish options: Trim: black, silver or white Body: white, grey, black, orange, red, green, blue 	\$651



ORDER CODE SAMPLE		
ITEM CODE	TRIM FINISH	BODY FINISH
AU1AE	SILVER	WHITE

Dual Power, Dual USB

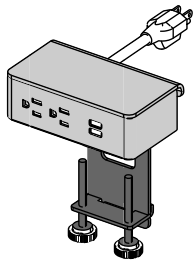

210 CLAMP ON

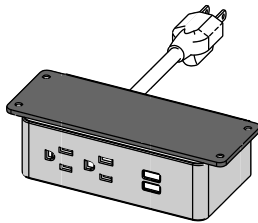

210 UNDERMOUNT

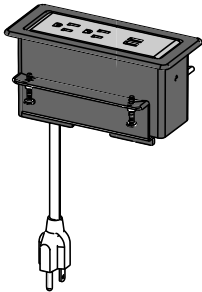

DUO FLUSH MOUNT

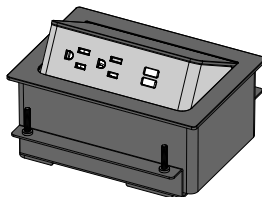

TILT FLUSH MOUNT

BODY
TRIM

AC2AE	
FEATURES & SPECIFICATIONS	PRICE
<ul style="list-style-type: none"> • Double outlet • Two USB ports • 72" Corded plug • Finish options: Trim: black, silver or white Body: white, grey, black, orange, red, green, blue 	\$707

AU2AE	
FEATURES & SPECIFICATIONS	PRICE
<ul style="list-style-type: none"> • Double outlet • Two USB ports • 72" Corded plug; optional 10' cord available • Finish options: Trim: black, silver or white Body: white, grey, black, orange, red, green, blue 	\$650

AF2AE	
FEATURES & SPECIFICATIONS	PRICE
<ul style="list-style-type: none"> • Double outlet • Two USB ports • 72" Corded plug • Finish options: Trim: black, silver or white Body: white, grey, black, orange, red, green, blue 	\$661

AT2FE	
FEATURES & SPECIFICATIONS	PRICE
<ul style="list-style-type: none"> • Double outlet • Two USB ports • 72" Corded plug • Finish options: Trim: black, silver or white Body: white, grey, black, orange, red, green, blue 	\$1,130

ORDER CODE SAMPLE		
ITEM CODE	TRIM	BODY
AF2AE	BLACK	GREY

Three Power, Dual USB

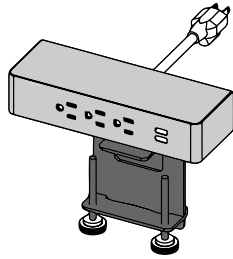

TRIO CLAMP ON

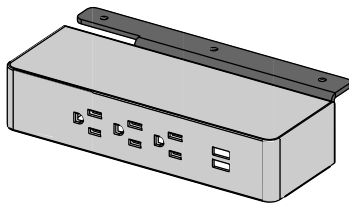

TRIO UNDERMOUNT

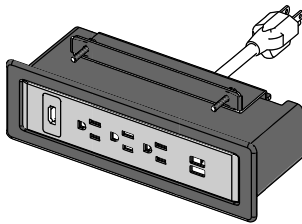

TRIO FLUSH MOUNT

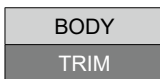

AC3AE	
FEATURES & SPECIFICATIONS	PRICE
<ul style="list-style-type: none"> • Triple outlet • Two USB ports • 72" Corded plug • Finish options: Trim: black, silver or white Body: white, grey, black, orange, red, green, blue 	\$805

AU3AE	
FEATURES & SPECIFICATIONS	PRICE
<ul style="list-style-type: none"> • Triple outlet • Two USB ports • 72" Corded plug • Finish options: Trim: black, silver or white Body: white, grey, black, orange, red, green, blue 	\$723

AF3AE	
FEATURES & SPECIFICATIONS	PRICE
<ul style="list-style-type: none"> • Triple outlet • Two USB ports • 72" Corded plug • Finish options: Trim: black, silver or white Body: white, grey, black, orange, red, green, blue 	\$780



ORDER CODE SAMPLE		
ITEM CODE	TRIM FINISH	BODY FINISH
AF3AE	SILVER	WHITE

Top Mount Tilting

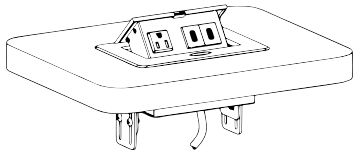

SINGLE OUTLET, 2 USB

AT1FE	
FEATURES & SPECIFICATIONS	PRICE
<ul style="list-style-type: none"> • Single outlet • 2 USB charging ports with separate power adapter • Push button tilting mechanism • 96" black power cable • Finish options: silver only 	\$589



ORDER CODE SAMPLE
ITEM CODE
AT1FE

Surface Mount Power & Dual USB

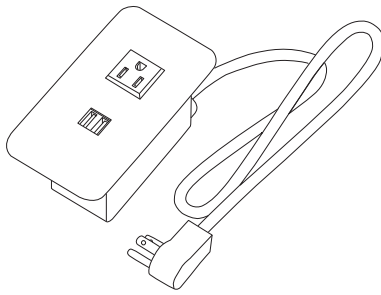

**COVE SURFACE MOUNT
SINGLE**

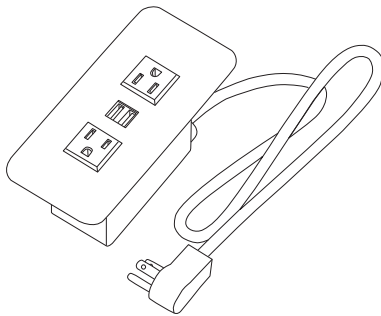

**COVE SURFACE MOUNT
DUAL**

AF1BE	FINISH	
FEATURES & SPECIFICATIONS	PRICE (BLACK, SILVER, WHITE)	PRICE (ANODIZED ALUMINUM)
<ul style="list-style-type: none"> • Single outlet • Dual USB charging outlets • 108" Black corded plug • Finish options: black, silver, white or clear brushed aluminum 	\$984	\$1,120

AF2BE	FINISH	
FEATURES & SPECIFICATIONS	PRICE (BLACK, SILVER, WHITE)	PRICE (ANODIZED ALUMINUM)
<ul style="list-style-type: none"> • Dual outlet • Dual USB charging outlets • 108" Black corded plug • Finish options: black, silver, white or clear brushed aluminum 	\$1,287	\$1,430



ORDER CODE SAMPLE	
ITEM CODE	FINISH
AF1BE	SILVER

Pop-Up Wireless Charger with 2 USB

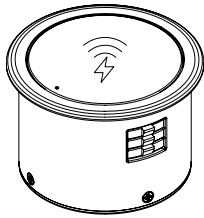

CLOSED - FLUSH

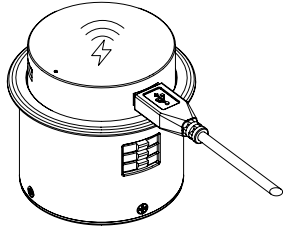

OPEN - USB ACCESS

WIRELESS CHARGING

AF0WE

FEATURES & SPECIFICATIONS

- Flush mount
- Pop up design allows simultaneous wireless and access to three USB charging ports
- Three inch hole required for mounting
- Qi compatible
- Will charge through surface up to 1/8"
- Finish options: black only

PRICE

\$431



ORDER CODE SAMPLE

ITEM CODE

AF0WE



Pop Up- Power Station

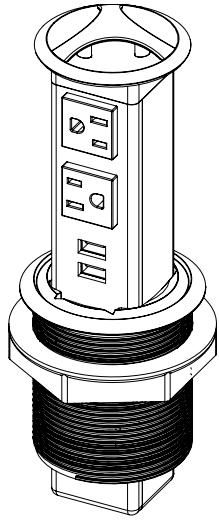

RETRACTABLE POWER STATION

AP2FE	
FEATURES & SPECIFICATIONS	PRICE
<ul style="list-style-type: none"> • Three inch hole required for mounting • Two AC receptacles, 120v/ 60hz • Two USB 2.1A charging ports • Requires 12" (305mm) space under work surface • Pull up design • 6Ft grounded power cord • Finish options: black only 	\$453



ORDER CODE SAMPLE
ITEM CODE
AP2FE

Clamp On Power Module

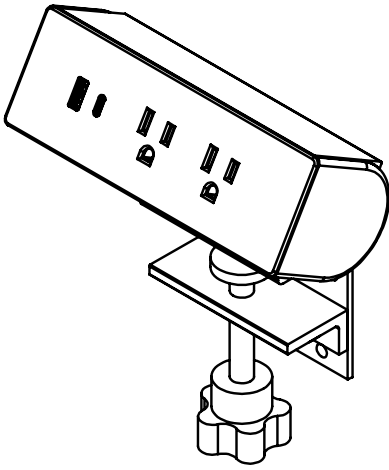

AC2BE	
FEATURES & SPECIFICATIONS	PRICE
<ul style="list-style-type: none"> • Desk mount clamp • Two 15A, 125V AC power outlet • One USB-A power port & one USB-C power port • 9ft Grounded power cord • Finish options: black or white • Size: 6.18" w x 4.43"d x 3.5" h 	\$340



ORDER CODE SAMPLE
ITEM CODE
AC2AC

Under Desk Storage

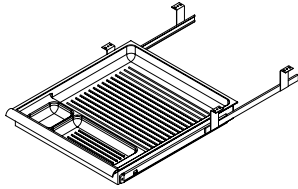

3 COMPARTMENT PENCIL DRAWER

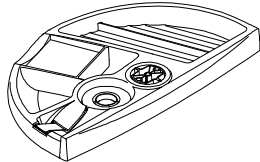

LARGE CIRCULAR DRAWER

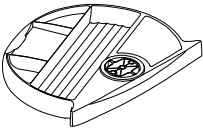

SMALL CIRCULAR DRAWER

AP12A	
FEATURES & SPECIFICATIONS	PRICE
<ul style="list-style-type: none"> • Slide out design • Integral plastic slides mount easily under worksurface • Textured plastic • Finish options: black • Width: 15 1/4" • Installed depth: 15 1/4" • Extended depth: 26" 	\$166

AP13A	
FEATURES & SPECIFICATIONS	PRICE
<ul style="list-style-type: none"> • Circular swivel design • Under work surface application • 13 19/32" Long, 1 1/4" high, 7 13/32" deep • Plastic • Finish options: matte black, metallic silver 	\$231

AP14A	
FEATURES & SPECIFICATIONS	PRICE
<ul style="list-style-type: none"> • Circular swivel design • Under work surface application • 9" Long, 1" high, 7 13/32" deep • Plastic • Finish options: matte black, metallic silver 	\$240



ORDER CODE SAMPLE	
ITEM CODE	FINISH
AP14A	BLACK

Grommets



3" GROMMET



2.5" GROMMET



1.75" GROMMET

AG30A		
FEATURES & SPECIFICATIONS	PRICE GROMMET ONLY	PRICE INSTALLED
<ul style="list-style-type: none"> • Round grommet with removable cover • Fits 80mm hole • Finish: black or white 	\$38	\$86

AG25A		
FEATURES & SPECIFICATIONS	PRICE GROMMET ONLY	PRICE INSTALLED
<ul style="list-style-type: none"> • Round grommet with removable cover • Fits 60mm hole • Finish: black only 	\$37	\$85

AG17A		
FEATURES & SPECIFICATIONS	PRICE GROMMET ONLY	PRICE INSTALLED
<ul style="list-style-type: none"> • Round grommet with removable cover • Fits 45mm hole • Finish: black only 	\$36	\$84



ORDER CODE SAMPLE	
ITEM CODE	OPTION
AG25A	<i>BLACK</i>

CPU Holders

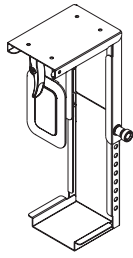

MINI FIXED MOUNT

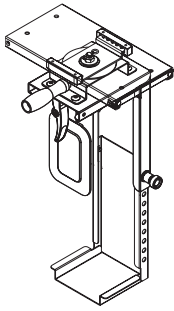

MINI SLIDE AND SWIVEL

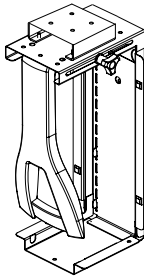

FULL SIZE FIXED MOUNT

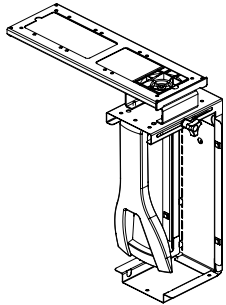

FULL SIZE SLIDE & SWIVEL

ORDER CODE	ACCOMMODATES CPU SIZE		
MODEL	HEIGHT RANGE	WIDTH RANGE	PRICE
ACP1A	7.9" - 14	2" - 4	\$250

FEATURES & SPECIFICATIONS			
<ul style="list-style-type: none"> • Finished in black textured powdercoat • Plastic side clamp with bumpers • Side mountable • Fixed unit; does not swivel or retract • Depth: 4.5" • Weight: 8.0 lbs • capacity: 22 lbs 			

ORDER CODE	ACCOMMODATES CPU SIZE		
MODEL	HEIGHT RANGE	WIDTH RANGE	PRICE
ACP2A	3.9" - 14	2" - 4	\$356

FEATURES & SPECIFICATIONS			
<ul style="list-style-type: none"> • Finished in black textured powdercoat • Plastic side clamp with bumpers • Side mountable • Depth: 4.5" • Weight: 8.0 lbs • capacity: 22 lbs 			

ORDER CODE	ACCOMMODATES CPU SIZE		
MODEL	HEIGHT RANGE	WIDTH RANGE	PRICE
ACP3A	14.5" - 22.5	3.5" - 9.3	\$540

FEATURES & SPECIFICATIONS			
<ul style="list-style-type: none"> • Finished in black textured powdercoat • Plastic side clamp with bumpers • Side mountable • Fixed unit; does not swivel or retract • Weight: 8.0 lbs • capacity: 50 lbs 			

ORDER CODE	ACCOMMODATES CPU SIZE		
MODEL	HEIGHT RANGE	WIDTH RANGE	PRICE
ACP4A	14.5" - 22.5	3.5" - 9.3	\$808

FEATURES & SPECIFICATIONS			
<ul style="list-style-type: none"> • Finished in black textured powdercoat • Plastic side clamp with bumpers • Ball bearing track slide is 17" deep • 360° Swivel • Side mountable • Weight: 12.4 lbs • Capacity: 50 lbs 			

▽

ORDER CODE SAMPLE
ITEM CODE
ACP4A

Monitor Arms & TV Mounts

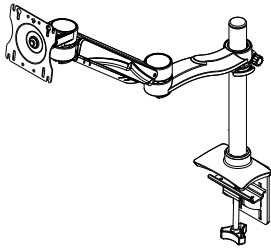

SINGLE MONITOR ARM

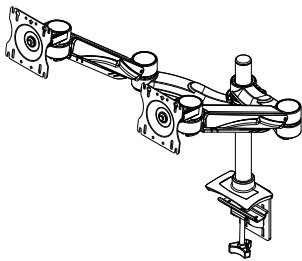

DUAL MONITOR ARM

ORDER CODE	SIZE	
MODEL	HEIGHT RANGE	PRICE
AMA1A	12.4	\$664
FEATURES & SPECIFICATIONS		
<ul style="list-style-type: none"> • Finished in silver powdercoat • 20lbs load capacity • Desk clamp and grommet mount hardware included • Integrated cable management • Vesa mount accommodates 75mm and 100mm hole patterns • Included allen wrench adjustment 		

ORDER CODE	SIZE	
MODEL	HEIGHT RANGE	PRICE
AMA2A	12.4	\$1,152
FEATURES & SPECIFICATIONS		
<ul style="list-style-type: none"> • Finished in silver powdercoat • 20lbs load capacity per screen • Desk clamp and grommet mount hardware included • Integrated cable management • Vesa mount accommodates 75mm and 100mm hole patterns • Maximum 35" screen width • Included allen wrench adjustment 		



ORDER CODE SAMPLE	
ITEM CODE	FINISH
AMA2A	SILVER

Keyboard Combos

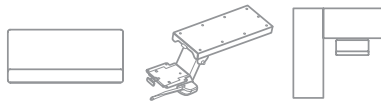

KBTW27 / KBWS-L17

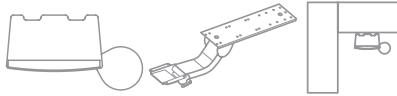

KBT(MS)RM / KBSS

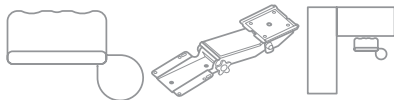

KBT(90)BRM / KBKS-21



KBC-12 / KBWS-L22

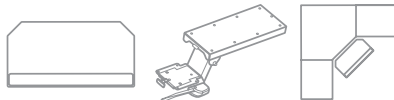

KBT-DC17 / KBWS-L22

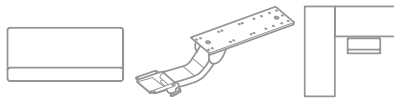

KBTW27 / KBSS

AK04A	
FEATURES & SPECIFICATIONS	PRICE
<ul style="list-style-type: none"> • Standard 27" wide rectangular tray. • Keyboard and mouse tray with vinyl wrist rest • Finish: black only 	\$1,129

AK06A	
FEATURES & SPECIFICATIONS	PRICE
<ul style="list-style-type: none"> • Composite tray, reversible mouse tray, wrist rest & wire guide • KBSS mechanism extends above and below desk • Finish: black only 	\$1,688

AK09A	
FEATURES & SPECIFICATIONS	PRICE
<ul style="list-style-type: none"> • Composite tray, reversible mouse tray, wrist rest & wire guide • Finish: black only 	\$725

AK10A	
FEATURES & SPECIFICATIONS	PRICE
<ul style="list-style-type: none"> • Keyboard platform with wrist rest • Rear surface radiused for 12" corners • Finish: black only 	\$1,206

AK11A	
FEATURES & SPECIFICATIONS	PRICE
<ul style="list-style-type: none"> • Keyboard platform with wrist rest • Rear surface has notched corners to fit 18" diagonal corner • Finish: black only 	\$830

AK12A	
FEATURES & SPECIFICATIONS	PRICE
<ul style="list-style-type: none"> • 27" Wide rectangular laminate tray with vinyl wrist rest • KBSS mechanism extends above and below desk • Finish: black only 	\$1,028



ORDER CODE SAMPLE
ITEM CODE
AK10A

Keyboard Platforms

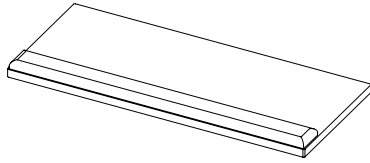

RECTANGULAR PLATFORM WITH WRIST REST

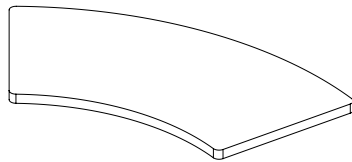

CURVED PLATFORM WITH WRIST REST

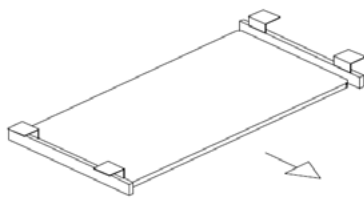

RETRACTABLE KEYBOARD TRAY

ORDER CODE	SIZE	
MODEL	WIDTH	PRICE
AKBTA	20	\$216
AKBTA	26	\$288
AKBTA	27	\$288
AKBTA	28	\$288
AKBTA	30	\$297

FEATURES & SPECIFICATIONS
<ul style="list-style-type: none"> • Upholstered vinyl padded wrist rests available in black only • Laminate keyboard constructed of 0.75" LPL • Includes mounting inserts on underside • Laminate tray available in black only • Depth is 12"

ORDER CODE	SIZE	LAMINATE			
MODEL	WIDTH	DEPTH	RADIUS	PRICE M1	PRICE H1
AKBCA	28	16.5	18	\$228	282
AKBCA	30	16	24	\$228	282

FEATURES & SPECIFICATIONS
<ul style="list-style-type: none"> • Designed to fit all BRC curved corner with same radius • Includes mounting inserts on underside • Laminate tray available in black only • For straight front keyboard, add 'SF' to code • Laminate keyboard constructed of 1" LPL or 1" HPL

ORDER CODE	SIZE	
MODEL	WIDTH	PRICE
AKBRA	21	\$155
AKBRA	28	\$155

FEATURES & SPECIFICATIONS
<ul style="list-style-type: none"> • Retractable tray with lock out feature • Laminate keyboard constructed of 0.75" LPL • Fixed height clearance user defined during installation • Can be installed under minimum 20" deep worksurface • Laminate tray available in black only • Depth is 12"



ORDER CODE SAMPLE	
ITEM CODE	SIZE
AKBRA	28"

Keyboard Mechanisms

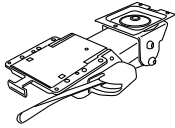

**HEIGHT ADJUSTABLE
KEYBOARD MECHANISM**

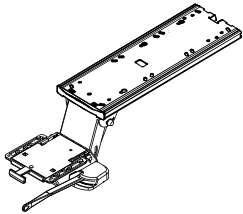

**HEAVY DUTY KEYBOARD
MECHANISM**

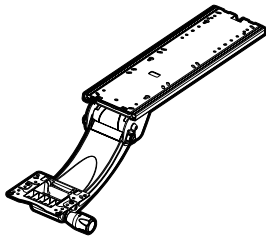

**HEAVY DUTY KEYBOARD
MECHANISM 2**

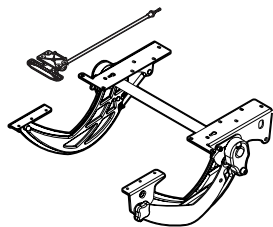

**HEAVY DUTY PADDLE
ADJUSTABLE DOUBLE
ARM KEYBOARD TRAY**

ORDER CODE	SIZE	
MODEL	WEIGHT/CUBE	PRICE
AKM1A	8/1.0	\$536

FEATURES & SPECIFICATIONS

- Non retractable & height adjustable for worksurfaces of all depths
- 6" Height adjustment using lever lock actuator
- Easy pull tab activates tray tilt feature
- 15 Degrees positive or 10 degrees negative tray tilt

ORDER CODE	SIZE		
MODEL	WEIGHT/CUBE	Size	PRICE
AKM2A	11/1.5	22	\$679
AKM2A	11/1.5	17	\$679

FEATURES & SPECIFICATIONS

- Fully retractable low profile support mechanism
- 24" Minimum worksurface depth required
- 6" Height adjustment using lever lock actuator
- Easy pull tab activates tray tilt feature
- 15 Degrees positive or 10 degrees negative tray tilt
- Steel ball bearing slide mechanism

ORDER CODE	SIZE	
MODEL	WEIGHT/CUBE	PRICE
AKM3A	11/1.5	\$1,120

FEATURES & SPECIFICATIONS

- Fully retractable low profile support mechanism
- 24" Minimum worksurface depth required
- 6" Height adjustment using lever lock actuator
- Easy pull tab activates tray tilt feature
- 15 Degrees positive or 10 degrees negative tray tilt
- Steel ball bearing slide mechanism

ORDER CODE	SIZE		
MODEL	WIDTH	DEPTH	PRICE
AKM4A	23	20	\$835
AKM4A	27	20	\$1,112

FEATURES & SPECIFICATIONS

- Includes 0.75" LPL black tray

OPTIONAL EXTRA

- Matching laminate available; specify on order and add \$250



ORDER CODE SAMPLE	
ITEM CODE	SIZE
AKM4A	23"

For more information contact: quotes@brc.group

24 Armstrong Ave
Georgetown, ON L7G 4R9
Phone: 905.873.8509
Toll Free: 1.877.260.4309
info@brc.group

